



EcoNet[®] Enabled Unit Coolers



Installation and Operations Manual

Table of Contents

Introduction and Board Layout	2
Safety Considerations	3
System Installation	3-4
Start-Up/Commissioning.....	5
Operational Overview	10
Diagnostics	11
Group Operation	13-14
Door Switch	14-15
Compressor Control (Package Refrigeration Units) ¹	15-16
Defrost Heater Pump Down Delay	16-17
Leak Detection.....	18-19
Operational Limits	19
Replacement Parts and Part Numbers	19
Typical Wiring for Multiple Controllers	30-31
Addendum	32-35
EcoNet Command Center	
Safety Considerations	20
Installation and Mounting Instructions	20
Wiring Considerations.....	21
User Guide	20-24
Maintenance	22
Installer Settings	26-31

EcoNet® Enabled Unit Coolers

Introduction

EcoNet® Enabled Unit Coolers are intelligent, electronically operated evaporators for walk-in coolers and freezers designed for easier installation and energy savings. Developed in conjunction with Rheem Manufacturing, it builds on the success, reliability and efficiency of the EcoNet technology and brings it to commercial refrigeration.

EcoNet Enabled Unit Coolers save energy in refrigeration systems through precise superheat and space temperature control, fan cycling, and controlling how often the system goes into defrost based on compressor runtime. It eliminates unnecessary defrosts, maximizes energy efficiency with less compressor runtime, reduces liability by eliminating icing issues, reduces fan speed to 50% during off cycle to save energy, and reduces temperature fluctuations by regulating defrosts for improved product quality. EcoNet Enabled Unit Coolers can be configured to work on a single or dual evaporator coil, and can be used with a condensing unit in single and multiple evaporator installations as a group.

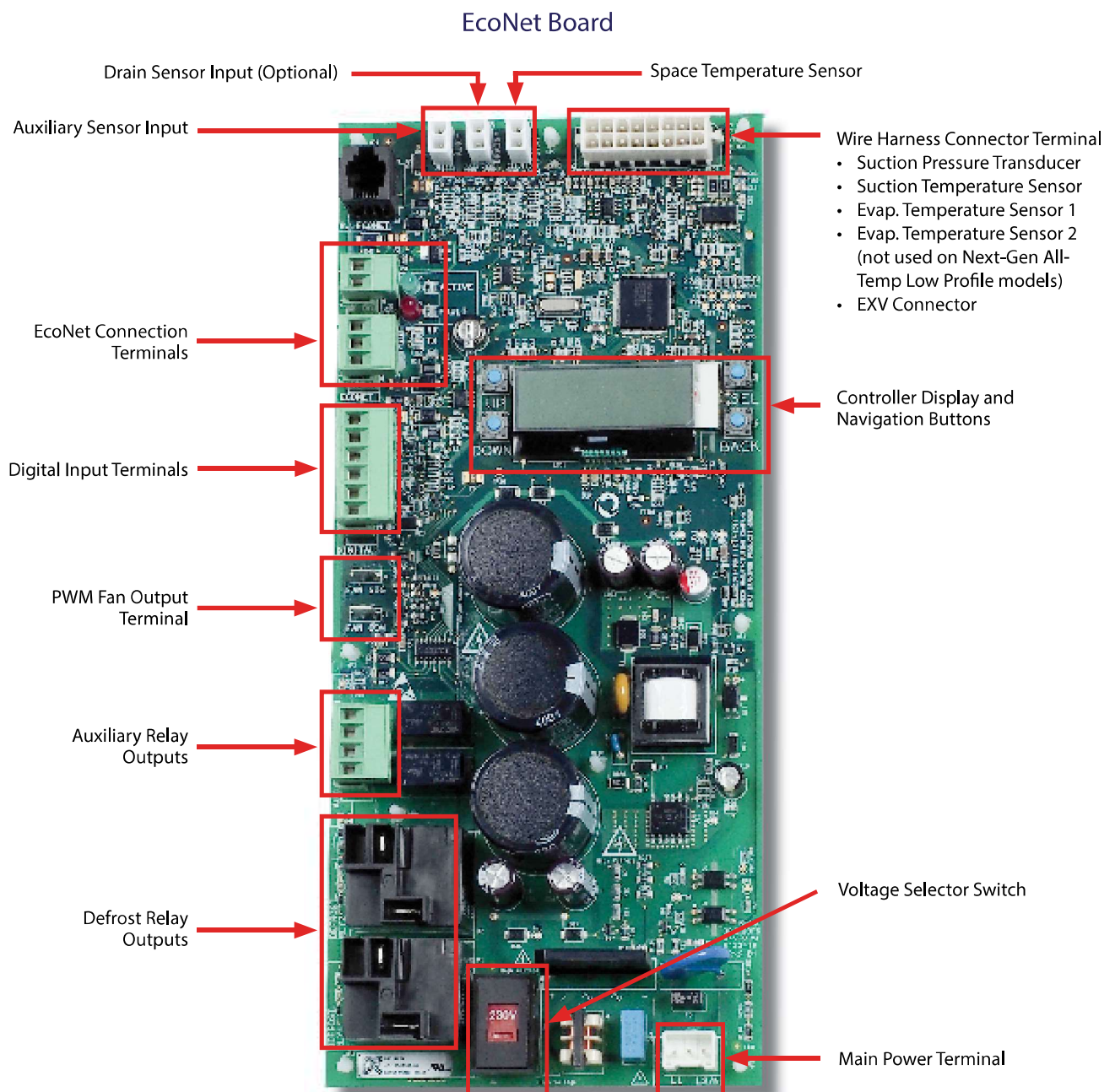

Figure 1

Installation and Operations Manual

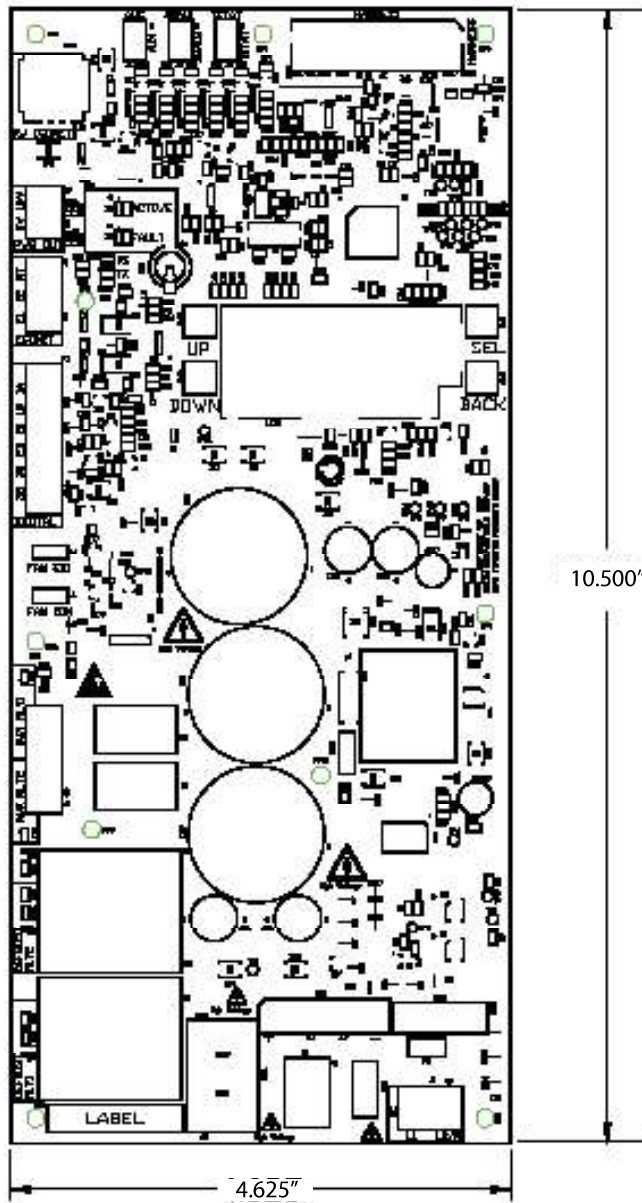

Figure 2

- Before service, power to the unit should be disconnected per proper lockout procedures.
- After power is disconnected wait 10 minutes before touching the board for power stored to fully discharge.
- The control board has no user serviceable parts, do not try to repair.
- Do not wire the control board while powered.
- If the board becomes corroded replace immediately.
- Cleaning of the control board is not recommended.

System Installation

Evaporator

1. EcoNet Enabled Unit Coolers ship with the EcoNet controller installed and all sensors and relays wired. Prior to installation, you must verify that all sensors, defrost heaters and wire harnesses are securely connected to the controller board and terminal board.
2. Verify correct voltage from main power supply to evaporator unit. Set the Voltage Selector Switch (Figure 2) on the controller board to the correct voltage setting (115V/230V) before powering up the unit.

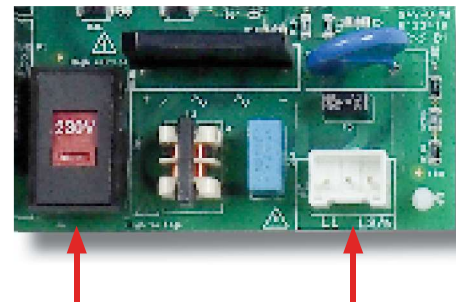

Voltage Selector Switch

Main Power Terminal

Figure 3

CAUTION: Having the Voltage Selector Switch set to incorrect voltage can damage the controller board when power is connected to it.

3. Connect main power to the evaporator unit at the L1/L2 and GND terminals on the terminal board as shown in the wiring diagram (Figures 2, 3, 4).

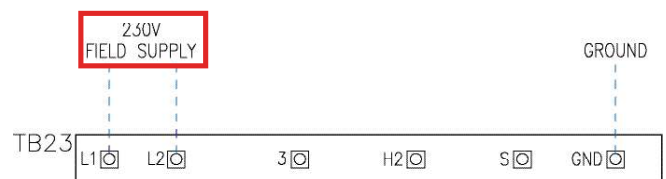

Figure 4

Safety Considerations

Failure to read and follow all instructions carefully before installing or operating this control and system could cause personal injury and/or property damage.

NOTE: All wiring must comply with national, local, and state codes.

WARNING: Disconnect power to the outdoor and indoor units before beginning installation.

- Only a trained service professional/contractor should use or interact with the control board.
- Never touch the control board surface directly to avoid static shock damage or exposure to high voltages.

EcoNet® Enabled Unit Coolers

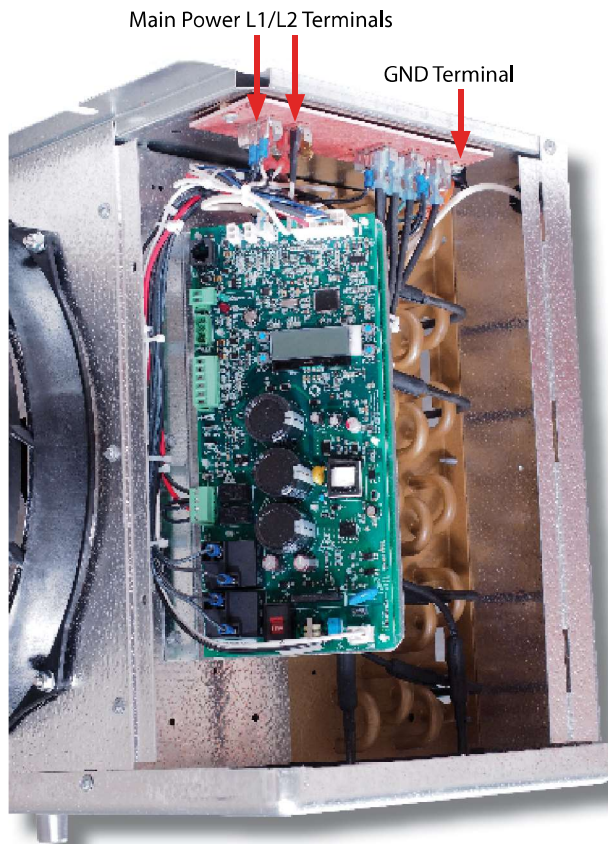

Figure 5

4. Prior to installation, please refer to factory label at evaporator unit for correct voltage and amp draw requirements to verify circuit breaker size where unit will be connected to.

Condensing Unit

1. If a defrost timer is installed on the condensing unit, make sure it is disconnected/disabled (all switches on time clock should be in the OFF position) (Figure 6). All defrost functions are performed by the controller board.
2. Please refer to factory label at condensing unit for correct voltage and amp draw requirements.

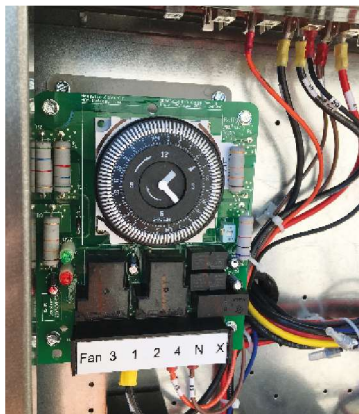

Figure 6

During System Installation

1. Refrigerant Line Brazing
 - a. Cover EXV with wet rag to protect from excess heat from torch.
 - b. Suction Temp Sensor (Figure 7) must be removed from the suction line prior to brazing. The sensor must be reinstalled on the suction line (10 or 2 o'clock position) after brazing is completed and the tubing has been allowed to cool down. Use nylon tie straps to secure the Suction Temp thermistor as shown in Figure 7. After suction temp sensor is installed, suction line should be insulated and the sensor should be covered with the insulation.

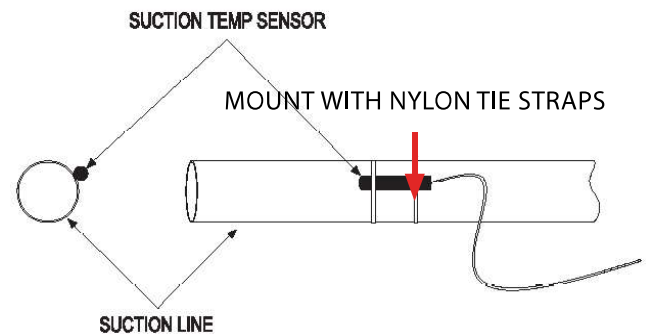

Figure 7

2. Purging Lines (pulling vacuum), two options:
 - a. To purge lines on system with EXV closed, make sure that controller is off, and pull vacuum from both suction and discharge ports at the condensing unit.
 - b. OR, to purge lines on system with EXV open, power up the controller and wait a couple of minutes for the controller to command the valve to open. Leave controller powered on while system evacuation is being done.
3. While charging the system with refrigerant, ensure that the EXV is open by powering up the controller and waiting a couple of minutes for the controller to command the EXV to open. With the controller powered on while the system is being charged, make sure to monitor the suction pressure, suction temperature, and superheat via the controller display and also via installer's gauges. Please refer to Display Status under the Startup/Commissioning section to show on the controller display the current suction temperature, suction pressure, EXV position and calculated superheat.

NOTES:

- If there is a power loss at any time during normal system operation, the controller will close the EXV, forcing a pumpdown.
- When starting up the system for the first time, the controller will turn the fans on when the Evap Temp gets below a preset temperature.
- EcoNet EXV's have a flow direction arrow, but are bi-directional

Installation and Operations Manual

4. Power Supply

- a. Freezers require 230V for electric heaters; coolers can run on 115V or 230V. Please refer to factory label on evaporator unit for amp draw and voltage requirements for proper circuit sizing at the facility prior to installation.

NOTE: EcoNet evaporators should be powered by an independent circuit; they should not be powered from the condensing unit.

- b. Set the Voltage Selector Switch on the controller board to the correct voltage setting (115V/230V) before connecting power to the controller.
CAUTION: Having the voltage selector switch set to incorrect voltage can damage the controller board when power is connected to it.
- c. Connect main power to L1 and L2 on evaporator terminal board. Connect ground wire to GND on terminal board.
- d. Refer to unit wiring diagram attached to cover panel.
- e. If there is a power loss at any time during normal system operation, the controller will close the EXV, forcing a pumpdown. When power is restored, the controller will resume refrigeration operation.
- f. To force the EXV closed while leaving the controller powered on, at the display go to **Settings**→**System Enabled**→**No**. This disables the system (fans off, EXV closed). To re-enable the system, go to the same display screen and set **System Enabled**→**Yes**. Please refer to the Setting Navigation Overview on page 6.

2. Navigation Overview

a. Space Temp

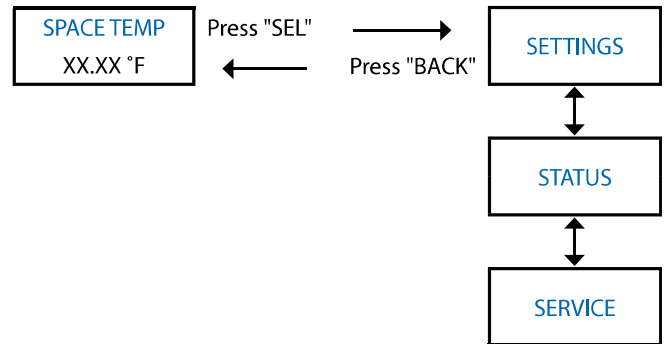

b. Settings Overview - see page 6

c. Status Overview - see page 7

d. Service

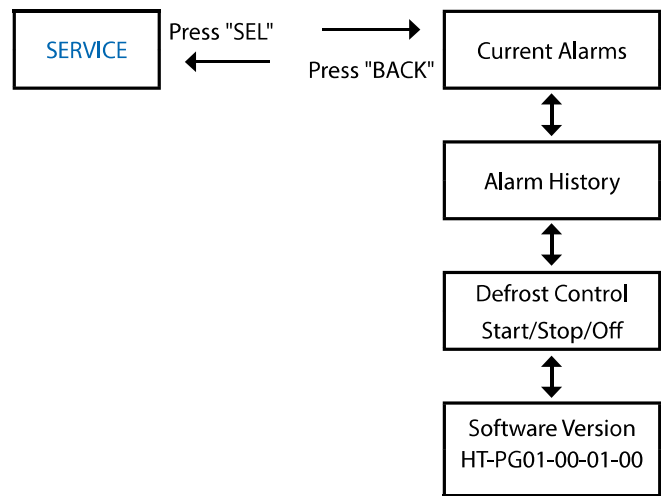

Start-Up/Commissioning

1. Local Display (Figure 8)

- a. Use the **UP/DOWN/SEL/BACK** buttons to navigate through the display.
- b. To change a parameter, navigate to it using the **UP/DOWN** buttons, press **SEL** until the value is flashing intermittently, use the **UP/DOWN** buttons to cycle through the selection, then press **SEL** again to confirm the selection.

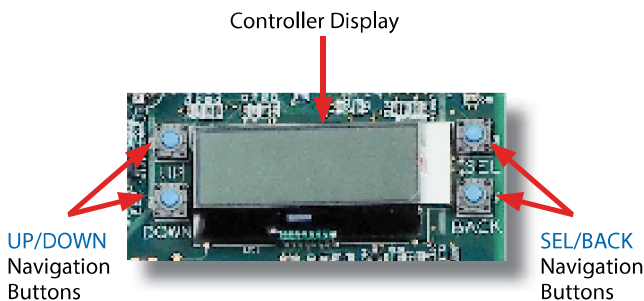
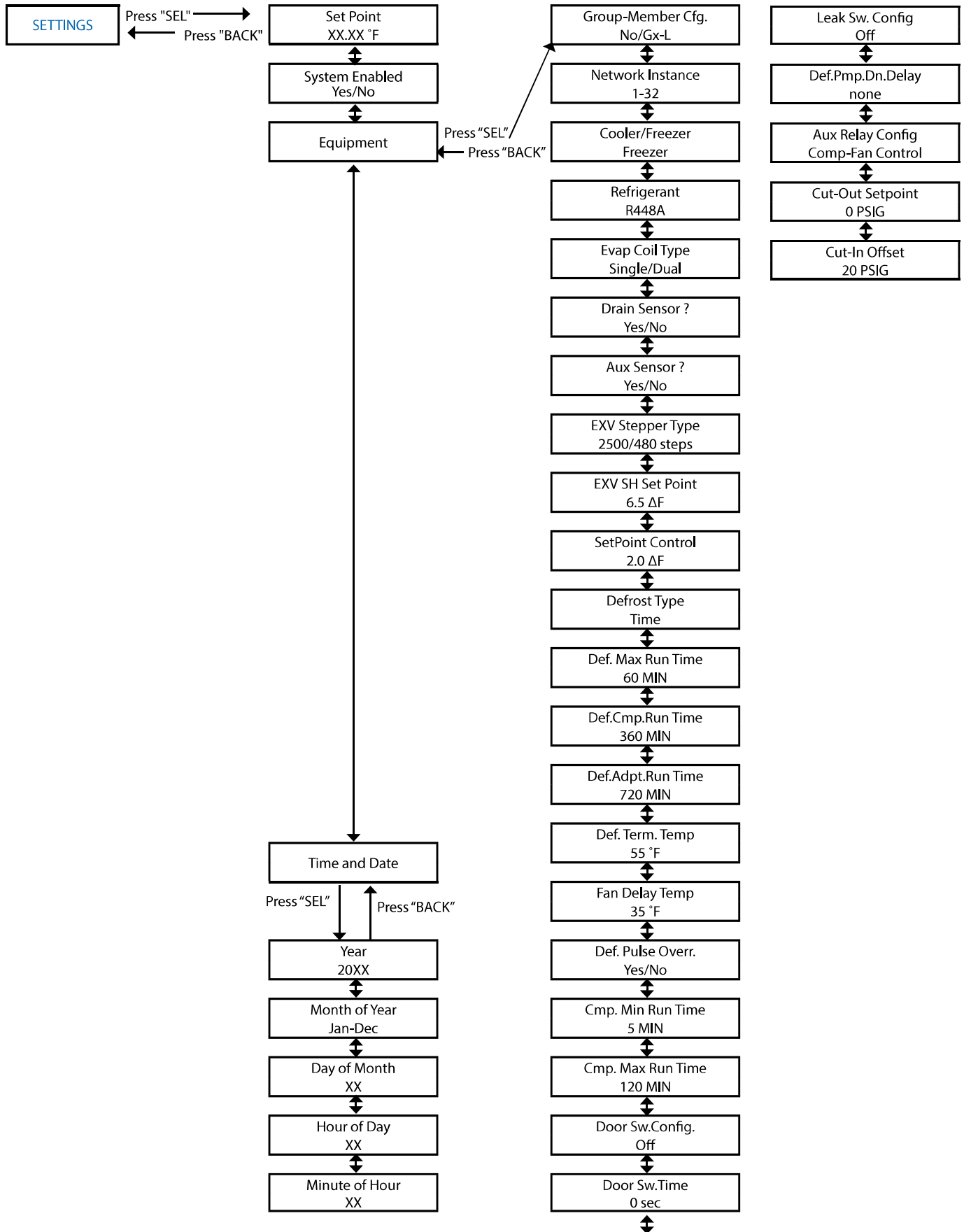

Figure 8

EcoNet® Enabled Unit Coolers

b. Settings Overview



Installation and Operations Manual

c. Status Overview

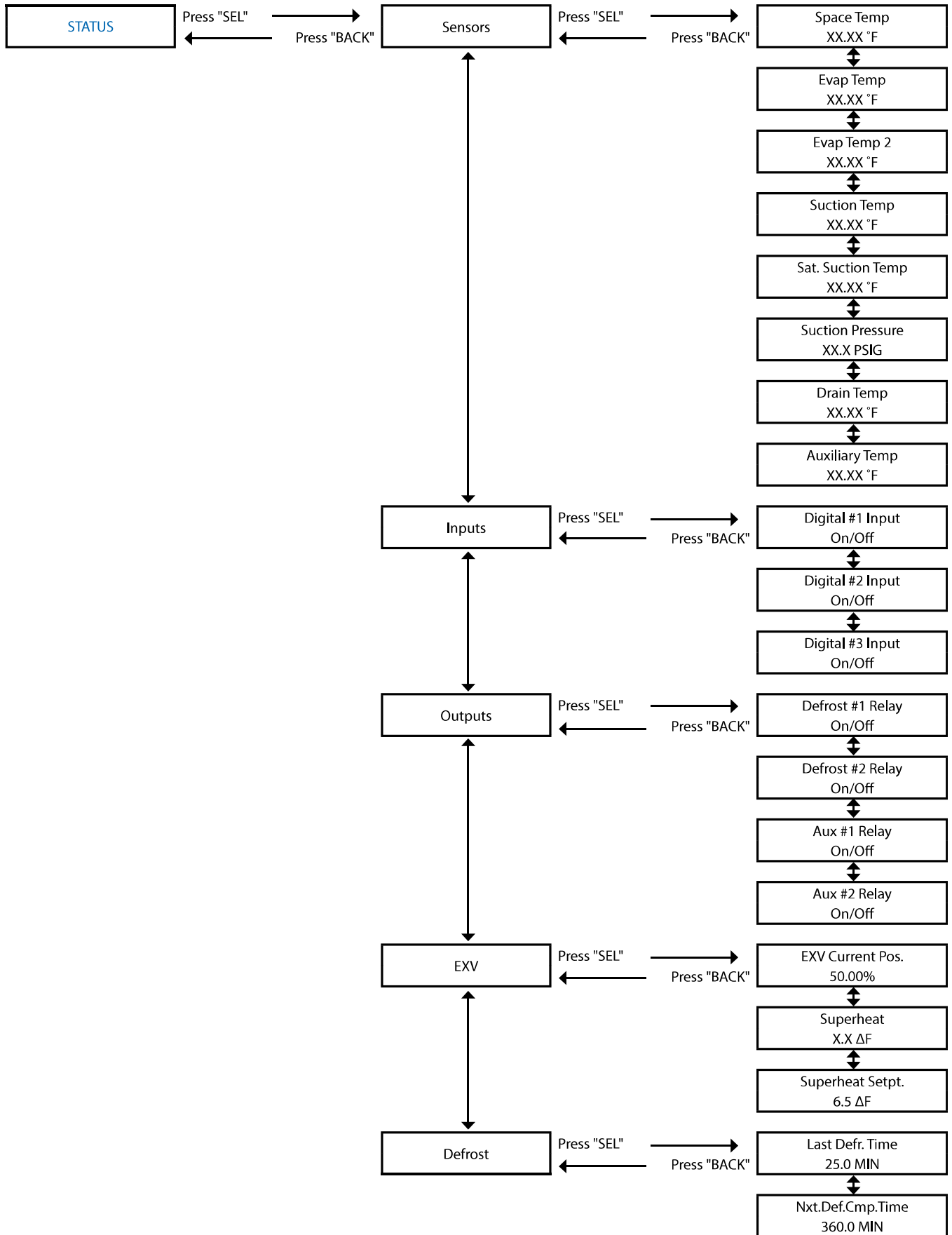

EcoNet® Enabled Unit Coolers

3. Parameters List

Parameter	Range	Default
System Enable	Yes or No	Yes
Setpoint*	25°F to 60°F (Cooler); -40°F to 35°F (Freezer)	-10°F
Group Member Cfg	(See group member list)	No
Network Instance	1 to 32	1
Cooler/Freezer*	Cooler or Freezer	Freezer
Refrigerant	(See supported refrigerants list)	R448A
Evap Coil Type*	Single or Dual	Single
Drain Sensor?	Yes or No	No
Aux Sensor?	Yes or No	No
EXV Stepper Type	2500 or 480 steps	2500 steps (Sporlan)
EXV SH Setpoint	4.0dF to 20.0dF	6.5dF
Setpoint Control	0.5dF to 20.0dF	2.0dF
Defrost Type ⁴	Timed/Adaptive	Timed
Def. Max Run Time	10 to 60 minutes	60 minutes
Def. Cmp. Run Time	0 to 900 minutes	360 minutes
Def. Adpt. Run Time ⁴	360 to 900 minutes	720 minutes
Def. Term. Temp ¹	35 °F to 65 °F	55 °F (Freezer); 40 °F (Cooler)
Fan Delay Temp ⁶	25 °F to 70 °F	35 °F (Freezer); 55 °F (Cooler)
Def. Pulse Ovr. ¹	Yes or No	Yes
Cmp. Min. Run Time ³	3 min/4 min/5 min	5 minutes
Cmp. Max. Run Time	0 to 480 minutes	120 minutes
Door Sw. Config. ²	Off - NO - NC	Off
Door Sw. Time ²	0 sec/30 sec/1 min/2 min/3 min/4 min/5 min	0 sec
Leak Sw. Config. ⁶	Off - NO - NC	Off
Def. Pmp. Dn. Delay ²	none/1 min/2 min/3 min/4 min/5 min	none (Fan Control); 1 min (Comp-Fan Control)
Aux Relay Config. ⁵	Comp-Fan Control; Fan Control	Comp-Fan Control
Cut Out Setpoint ⁵	-2 PSIG to 60 PSIG	0 PSIG (Freezer); 20 PSIG (Cooler)
Cut-In Offset ⁵	10 PSIG to 50 PSIG	20 PSIG

* NOTE: Parameters will be pre-selected on factory-installed EcoNet Enabled Unit Cooler boards to match equipment. Air defrost units will ship from factory preset to "Cooler" and "35OF". Electric defrost units will ship from factory preset to "Freezer" and "-10OF". Center Mount evaporators will ship with Evap Coil Type set to "Dual" and Def. Pulse Ovr. set to "Yes." Replacement EcoNet Enabled Unit Cooler boards will ship with the default parameters of "Freezer" and "-10OF". A trained service professional/contractor may adjust the preset depending on the equipment the board is being replaced in.

4. Parameter Definitions

- a. **System Enable:** Set to YES to enable controller cooling operation. Set to NO to force system pump down; controller will close the EEV and turn the fans off. Allows

for system pump down while controller is still powered on. NOTE: There is no time limit on this setting; make sure System Enable is set back to YES to allow controller to resume cooling operation.

- b. **Setpoint:** This is the room setpoint for the walk-in box. If the controller is configured as a "Cooler", the available room setpoint range is 25°F to 60°F; if the controller is configured as a "Freezer", the available room setpoint range is -40°F to 35°F (See "d" Cooler/Freezer parameter).
- c. **Group Member Cfg.:** This is to address the controller as part of a group if multiple evaporators will be wired together to cool the same space (See Group Operation, Command Center sections).
- d. **Network Instance:** This is to address the controller to work as a standalone unit, but wired to other evaporators on the same communication bus with a Command Center Display (See Command Center section).
- e. **Cooler/Freezer:** Set the controller for the type of operation it will be used in. If set as "Freezer", the controller will use the defrost relays to activate the electric heaters in the evaporator, and allow a drain time at the end of the defrost cycle. If set as "Cooler", the unit will operate as air defrost (off-cycle).
- f. **Refrigerant:** Set the refrigerant that will be used in the system from among the list of supported refrigerants.

Supported Refrigerants
R448A (Default)
R407A
R407C
R449A
R404A
R507A
R513A
R450A
R454C ⁴
R455A ⁴
R454A ⁶
R22 ⁶

- g. **Evap Coil Type:** Set for the type of evaporator being used. "Single" applies to Low Profile evaporators. "Dual" applies to dual coil designs such as Center Mount evaporators, where Evap Temp 2 sensor is used.
- h. **Drain Sensor?:** Set to configure if drain temp sensor is

¹ Feature available with controller software version HT-PG01-00-01-13 or newer.

² Feature available with controller software version HT-PG01-00-01-18 or newer.

³ Feature available with controller software version HT-PG01-00-01-21 or newer.

⁴ Feature available with controller software version HT-PG01-00-01-22 or newer.

⁵ Feature available with controller software version HT-PG01-00-01-23 or newer.

⁶ Feature available with controller software version HT-PG01-00-01-25 or newer.

Installation and Operations Manual

4. Parameter Definitions continued

- installed.
- i. Aux Sensor?: Not used.
 - j. EXV Stepper Type: Set to configure EXV type; 2500 steps or 480 steps. This should come preset from the factory and should not be changed.
 - k. EXV SH Setpoint: Set to configure desired superheat setpoint.
 - l. Setpoint Control: Set to configure desired hysteresis range for space temperature control. When the system is in Refrigeration mode, if the Space Temp Setpoint is -10°F with a default Setpoint control differential of 2.0 dF, the unit will continue to cool the space until the Space Temp. is just under -10°F . At this point, the system will pump down and run the fans at half speed. When the Space Temp rises to around -8°F , Refrigeration mode will start back up: EXV will open and the fans will run at full speed until Setpoint is reached again or the unit goes into defrost.
 - m. Def. Max Run Time: Set to configure the maximum allowed defrost time.
 - n. Defrost Type⁴: Select desired defrost algorithm: Timed or Adaptive. Note: this only applies if controller is set to Freezer. If controller is set to Cooler, Timed defrost will always remain as the functional setting. See Defrost Mode section on page 10 for more information.
 - o. Def. Cmp. Run Time: Set to configure the allowed compressor runtime before the unit goes into defrost when controller is set to Timed defrost. See Defrost Mode section on page 10 for more information.
 - p. Def. Adpt. Run Time⁴: Set to configure allowed compressor runtime before unit goes into defrost when controller is set to Adaptive defrost. See Defrost Mode section on page 10 for more information.
 - q. Def. Term. Temp¹: Sets the Defrost Termination Temperature; the temperature that the Evaporator has to reach in order to terminate the defrost cycle. NOTE: If the Cooler/Freezer parameter is manually adjusted, the Defrost Termination Temp setting will revert back to default (55°F for Freezer, 40°F for Cooler); if a value other than default is desired, make sure that Cooler/Freezer is set prior to adjusting the Defrost Termination Temperature.
 - r. Fan Delay Temp⁶: sets the fan delay temperature; temperature that the evaporator must reach before allowing the fans to run. NOTE: If the Cooler/Freezer parameter is manually adjusted, the Fan Delay Temp setting will revert to default (35°F for Freezer, 55°F for Cooler); if a value other than default is desired, make sure that Cooler/Freezer is set prior to adjusting the Fan Delay Temperature.
 - s. Def. Pulse Overr¹: Allows the user to override the pulsing function of Defrost Relay 1 (Top Heater on a Low Profile Evaporator). If the override of the Defrost Relay 1 pulsing is not desired, set to "No" (Relay 1 will pulse). If overriding the pulsing is desired, set to "Yes"; the Defrost Relay 1 will remain energized for the duration of the defrost cycle (Relay 1 will NOT pulse). NOTE: Def. Pulse Overr. must be set to "Yes" on Center Mount, dual coil evaporators for proper defrost performance.
 - t. Cmp. Min Run Time³: Adjust the minimum compressor run time for each cooling cycle. When refrigeration mode starts (EXV opens), the system will run for the minimum time that has been set. After this minimum time has elapsed, controller will pump down the system if Setpoint has been satisfied. Default setting is 5 minutes; can be adjusted to 3 minutes or 4 minutes. In a Group operation, only the Leader needs this setting adjusted; the Followers will start their refrigeration mode and pump down when commanded by the Leader.
 - u. Cmp. Max Run Time: Set to configure the allowed compressor runtime until Space Temperature Alarm is generated. If unit is actively cooling the space continuously for longer than this time period, an alarm will be generated to indicate that box has not achieved Setpoint.
 - v. Door Sw. Config.²: Configure Door Switch function as Normally Open (N.O.) or Normally Closed (N.C.) to enable Digital Input #1 to be used as contact for a door switch. Default setting is Off. Please refer to Door Switch section on page 13 for more information.
 - w. Door Sw. Time²: When Door Switch is configured, use this parameter to set desired delay to pump down the system when the door switch input (Digital Input #1) becomes inactive. Default is 0 seconds; can be configured to 30 seconds, 1 minute, 2 minutes, 3 minutes, 4 minutes or 5 minutes. NOTE: If Door Sw. Config. is set to Off, this parameter will not affect equipment operation. Please refer to Door Switch section on page 13 for more information.
 - x. Leak Sw. Config.⁶: Configure Leak Detector function as Normally Open (N.O.) or Normally Closed (N.C.) to enable Digital Input #2 to be used as contact for a leak detector device. Default setting is Off. Please refer to Leak Detection section on page 18 for more information.
 - y. Def. Pmp. Dn. Delay²: Set desired delay for pump down before electric heaters become active at the start of a defrost cycle. Default is None; can be set to 1 minute, 2 minutes, 3 minutes, 4 minutes or 5 minutes. NOTE: This parameter only affects units that are set to Freezer. See Defrost Heater Pump Down Delay section on pages 16-17 for more information.
 - z. Aux Relay Config.⁵
 - i. *Comp-Fan Control*: Controller will use Auxiliary Relay 1 for Evaporator Fan ON/OFF control, and Aux Relay 2 for Compressor ON/OFF control based on Suction Pressure transducer reading. Please refer to

¹ Feature available with controller software version HT-PG01-00-01-13 or newer.

² Feature available with controller software version HT-PG01-00-01-18 or newer.

³ Feature available with controller software version HT-PG01-00-01-21 or newer.

⁴ Feature available with controller software version HT-PG01-00-01-22 or newer.

⁵ Feature available with controller software version HT-PG01-00-01-23 or newer.

⁶ Feature available with controller software version HT-PG01-00-01-25 or newer.

EcoNet® Enabled Unit Coolers

Compressor Control section on page 15. **NOTE: This setting only applies to Packaged Refrigeration Units. Packaged Refrigeration Units MUST be set to Comp-Fan Control or damage to equipment will result!!!**

ii. **Fan Control:** Controller will use Auxiliary Relays 1 and 2 for Evaporator Fan ON/OFF control and speed control. **This setting is applicable for all other evaporator unit models. Not applicable for Packaged Refrigeration Units!!!**

- aa. Cut-Out Setpoint³: Pressure setpoint at which the compressor will turn off when Aux Relay Config. Is set to Comp-Fan Control. Please refer to Compressor Control section on page 15.
 - ab. Cut-In Offset³: Pressure differential for compressor to turn on when Aux Relay Config. is set to Comp-Fan Control. Please refer to Compressor Control section on page 15.
5. Display Status
- a. Sensors
 - 1) Space Temp
 - 2) Evap Temp
 - 3) Evap Temp 2 (not applicable on Low Profile evaporators)
 - 4) Suction Temp
 - 5) Saturated Suction Temp (conversion based on refrigerant selection)
 - 6) Suction Pressure Gauge
 - 7) Drain Temp (optional; requires sensor installed and configured)
 - 8) Aux Temp (not used)
 - b. Inputs
 - 1) Digital Inputs 1, 2 and 3
 - c. Outputs
 - 1) Defrost Relay 1 and 2
 - 2) Aux Relay 1 and 2
 - d. EXV
 - 1) EXV current position
 - 2) Calculated superheat
 - 3) Current superheat Setpoint
6. Defrost
- a. Last defrost elapsed time
 - b. Remaining runtime until next defrost
7. Service
- a. Current Alarms
 - 1) Use the **UP/DOWN** buttons on the display to cycle through the currently active alarms
 - b. Alarm History
 - 1) Use the **UP/DOWN** buttons on the display to cycle through the alarm history list.

NOTE: In order for the Alarm History time stamp to be accurate, the Time and Date must be configured on the controller (See Settings Overview, page 6, under the Start-Up/Commissioning section).
 - c. Defrost Control
 - 1) Use the **UP/DOWN** and **SEL** buttons to manually start/stop defrost cycle
 - d. Software version (displays current software version)

Operational Overview

Refrigeration Mode

When powered up, the controller will go through an initial startup procedure driving the EXV closed to ensure the valve is properly seated. If the space temperature is higher than the Space Temp Setpoint, the controller will attempt to cool the space: After a couple of minutes the EXV will start opening and the controller will keep actively metering the valve to achieve its superheat Setpoint. The fans will start after a delay to ensure that the evaporator coil is cold enough.

During normal refrigeration mode, the fans will run at full speed, and the EXV will continuously modulate to maintain superheat. In order to prevent compressor short cycling, the active refrigeration mode will run for a minimum of 5 minutes (adjustable via Cmp. Min Run Time; see page 8).

When the space temperature drops below the Space Temp Setpoint, the EXV will close forcing a pumpdown, and the fans will cycle to half speed. In order to prevent compressor short cycling, this inactive mode will run for a minimum of 2 minutes.

When the space temperature rises 2 degrees above the Setpoint (can be adjusted via Setpoint Control parameter), the EXV will start metering again and then fans will cycle back to full speed.

NOTE: If there is a power loss, the controller will close the EXV to force a pumpdown. When power is restored, the controller will go through its initial startup before resuming refrigeration functions again.

Defrost Mode

Timed Defrost (default setting)¹

With the controller set to Timed defrost, the defrost start time will vary depending on compressor run time. The controller will automatically start defrost when the Def. Comp. Run Time has elapsed (default 360 minutes), or manually when set by the user on the display **Service→Defrost Control→Start Defrosting**.

To set Defrost Type to Timed Defrost, navigate via the display to **Settings→Equipment→Defrost Type**, and select Timed.

To adjust the runtime until next timed defrost, navigate via the display to **Settings→Equipment→Def.Cmp.Run Time** and adjust the desired time.

NOTE: When the unit is actively cooling the space (EXV is metering, fans running at full speed) the controller is counting runtime towards the next defrost. When the space temperature Setpoint is satisfied (EXV closes for pumpdown, fans running at half speed) the controller does not count this as runtime towards the next defrost.

Adaptive Defrost (optional setting)²

With Adaptive defrost selected, the controller continuously monitors coil operation as indicated by EXV position over time and by temperatures. When both EXV and temperature conditions degrade past a certain point for a long enough period of time, the controller will automatically start a defrost cycle. At the same time, the controller keeps track of compressor runtime, and if the EXV and temperature conditions are not met, a defrost

¹ All software versions

² Feature available with controller software version HT-PG01-00-01-22 or newer.

³ Feature available with controller software version HT-PG01-00-01-24 or newer.

Installation and Operations Manual

Defrost Mode continued

will be started anyway after the Def. Adpt. Run Time (default 720 minutes) has expired. In other words, the controller will always start a defrost when the set runtime has expired, but it may also defrost beforehand if the EXV and temperature conditions are met. Alternatively, a defrost can be manually started by the user via the display by navigating to [Service→Defrost Control→Start Defrosting](#).

To set Defrost Type to Adaptive Defrost, navigate via the display to [Settings→Equipment→Defrost Type](#), and select Adaptive.

To adjust the maximum runtime for adaptive defrost, navigate via the display to [Settings→Equipment→Def.Adpt. Run Time](#), and adjust the desired time.

NOTE: Adaptive defrost is only available when the controller is set to Freezer. If the controller is set to Cooler, Timed defrost will always remain as the functional setting.

When a defrost cycle starts, the EXV will close for pumpdown.

- If unit is set as “Freezer” the electric heaters will be energized via the defrost relays, and the fans will cycle off. Defrost will end when evaporator coil reaches termination temperature or when Max. Defrost Run Time has elapsed (whichever comes first). The unit will then begin a 5 minute drain time. After the drain time has elapsed, the unit will resume normal refrigeration operation: EXV opens immediately and fans start when Evap Temp gets below a preset temperature. If Drain Temp sensor is installed and configured, the controller will monitor the drain pan temperature and generate an alarm if the drain pan does not get warm enough during a defrost cycle.
- If unit is set as “Cooler” the fans will cycle to half speed. Defrost will end when evaporator coil reaches termination temperature or when Max. Defrost Run Time has elapsed (whichever comes first). After the defrost cycle ends, the unit will resume normal refrigeration operation: EXV opens immediately and fans start when Evap Temp gets below a preset temperature.

NOTE: If controller has software version HT-PG01-00-01-18 or later, fans will run at 100% speed during air defrost cycle.

The remaining runtime until next defrost can be viewed on the display by selecting [Status→Defrost→Nxt. Def. Comp. Time](#).

The elapsed time for the last defrost can be viewed on the display by selecting [Status→Defrost→Last Defr. Time](#).

A defrost cycle can be stopped prematurely via the display if desired. At the display, select
When a defrost cycle starts, the EXV will close for pumpdown.

NOTE: If there is a power loss while the unit is in the middle of a defrost cycle, the controller will keep the EXV closed. When power is restored, the controller will go through its initial startup before resuming the defrost cycle. When the defrost cycle ends, the controller will resume refrigeration functions.

Recommended Freezer Defrost Parameter Settings

- Low Profile Evaporators: Set Defrost Termination Temperature between 55°F and 65°F; set Defrost Pulse Override to Yes or No, depending on conditions of the

Freezer.

- Center Mount Evaporators: Set Defrost Termination Temperature between 35°F and 40°F (adjust as necessary if defrost cycle is too long and steaming occurs); set Defrost Pulse override to Yes; Coil Type should be set to Dual.
- If defrost cycle is too long, keep in mind that the Max Defrost Time can also be adjusted down to terminate defrost before steaming occurs. Default is 60 minutes.
- If more defrost cycles are desired, the Runtime Until Defrost can be adjusted down so the unit will defrost more often throughout the day. Default is 360 minutes (6 hours of runtime).

Test/Service Mode

If the user desires to temporarily disable the system without disconnecting power to the unit, at the controller display select [Settings→System Enabled→No](#).

This function forces system pump down (EXV closes) and the fans turn off. The sensor inputs (temperatures, pressure, etc.) are still functional and can be viewed on the display.

To restart the system and enable cooling again, at the display select [Settings→System Enabled →Yes](#).

Diagnostics

The following sensors are continuously monitored and an alarm is generated in case of failure. A red LED at the controller board will light up to indicate active alarms. The active alarm automatically clears once the sensor is repaired or replaced.

Currently active alarms can be viewed on the display by selecting [Service→Current Alarms](#).

Any previously active alarms can be viewed in the display by selecting [Service→Alarm History](#).

- Space Temp
 - On failure, Cooling ON and OFF periods are run based on previous cycle averages.
- Evap Temp
 - On failure, defrost cycle will run until max defrost time (60 minutes) has elapsed.
- Evap Temp 2 (Not applicable on Low Profile Evaporators)
 - Same as Evap Temp 1, but only if Evap Coil Type = Dual
- Suction Temp
 - On failure, EXV remains open at a fixed position. No superheat calculation is available.
- Suction Pressure
 - On failure, Evap Temp will be used with Suction Temp to obtain approximate superheat calculation. If Evap Temp sensor input has also failed, EXV to remain open at a fixed position.
- Drain Temp (if applicable)

¹ All software versions

² Feature available with controller software version HT-PG01-00-01-22 or newer.

EcoNet® Enabled Unit Coolers

7. Defrost Failure: Max Time Expired
8. Door Open
9. Drain Time < Defrost Termination Temp.
10. Leak Detector
11. Aux Temp
12. Compressor not Pumping Down
13. Cooler/Freezer not Satisfying Setpnt.
14. Power Switch Mismatch
15. Configuration Data Restore Failure
16. Time Clock not Programmed
17. Time Clock not Advancing Time Properly

Group Operation

The EcoNet application supports multiple evaporator controllers to be connected together and work under a Leader/Follower setup as shown below. A maximum of 6 evaporators (1 Leader plus 5 Followers) can be configured on to a single group, and a maximum of 4 groups can be connected on to the same communication bus (see Figure 9).

When multiple controllers are addressed and connected to work as a group as shown below, the Leader of each group will command its followers when to cool the space, when to pump down, and when to start a defrost. Each group will work from a calculated average space temperature to determine if the space needs cooling. When a group is in active cooling mode, each evaporator in the group will meter its own EXV based on its individual superheat calculation. The Leader will keep track of the system runtime and command the Followers in its group to start a defrost cycle as necessary. When a defrost cycle ends, the Leader will command the Followers in its group to start cooling the space simultaneously after every member of the group has finished defrosting.

Each controller to be connected on the communication bus should be powered up and addressed individually before being connected to the other controllers in the daisy chain.

When setting up a group for the first time, the following parameters only need to be set at the Leader. The Leader will broadcast these settings to any connected followers in its group.

1. Setpoint¹
2. Refrigerant¹
3. Cooler/Freezer¹
4. Runtime Until Defrost, Timed (Def. Cmp. Run Time)²
5. Defrost Pump Down Delay²
6. Defrost Type³
7. Runtime Until Defrost, Adaptive (Def. Adpt. Run Time)³

NOTE: When linking multiple controllers in a group, make sure that every controller within a group has the same software version.

Group Member List	Description
No	Standalone Unit
G1-L	Group 1 Leader
G1-2	Group 1 Followers
G1-3	
G1-4	
G1-5	
G1-6	
G2-L	Group 2 Leader
G2-2	Group 2 Followers
G2-3	
G2-4	
G2-5	
G2-6	
G3-L	Group 3 Leader
G3-2	Group 3 Followers
G3-3	
G3-4	
G3-5	
G3-6	
G4-L	Group 4 Leader
G4-2	Group 4 Followers
G4-3	
G4-4	
G4-5	
G4-6	

Figure 9

To address each individual controller via the display select **Settings→Equipment→Group Member Cfg.**

In order to set up the communication bus, multiple controllers have to be wired together on a “daisy-chain” configuration. To “daisy chain” the units on the network, each unit should be connected to the EcoNet communication terminals (E1, E2, RT) as shown below and in Figure 11 on page 27 and Figure 12 on page 28

- Use minimum 18 to 22 AWG shielded cable with shunt capacitance of 16 pF per foot and 100 ohm impedance.

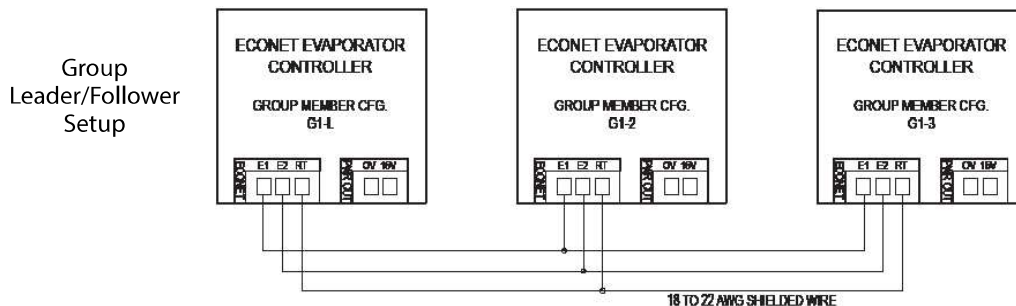

¹ All software versions
² Feature available with controller software version HT-PG01-00-01-18 or newer.
³ Feature available with controller software version HT-PG01-00-01-22 or newer.

EcoNet® Enabled Unit Coolers

Group Operation continued

- Ensure that communication wiring polarity is consistent on all controllers being wired together.
- A maximum of 32 devices including the Command Center can be daisy chained together on a single communication bus.
- Maximum wiring length of communication bus from first device to last device is 1,000 ft.
- The controllers can be wired in any order.

Door Switch¹

The EcoNet evaporator controller can be paired with a door switch to pump down the system and turn off the fans. Please follow the steps below to wire and configure a door switch.

1. Wiring the Door Switch

Wire door switch or toggle switch to Digital Input #1 (terminals 1A and 1B) using 18-20 AWG wire.

Input is a dry contact; no external voltage source needed.

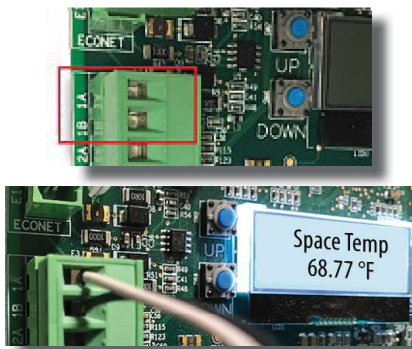
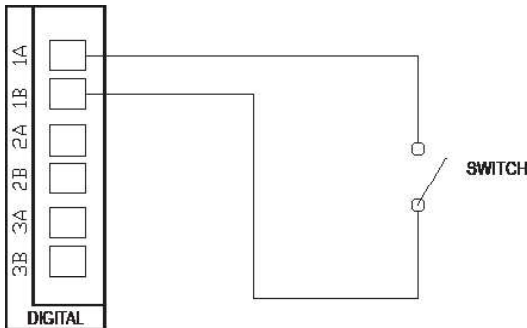

2. Configuring the Door Switch

Use the **UP/DOWN/SEL/BACK** buttons to navigate to **Settings**→**Equipment**.

Under Equipment, navigate to Door Sw. Config.

Press **SEL** button, default setting (Off) will start flashing.

2. Configuring the Door Switch continued

Use **UP** or **DOWN** buttons to adjust to desired door switch operation. Press **SEL** button again to confirm change.

Default setting is "Off"; can be configured as Normally Open (N.O.), or Normally Closed (N.C.).

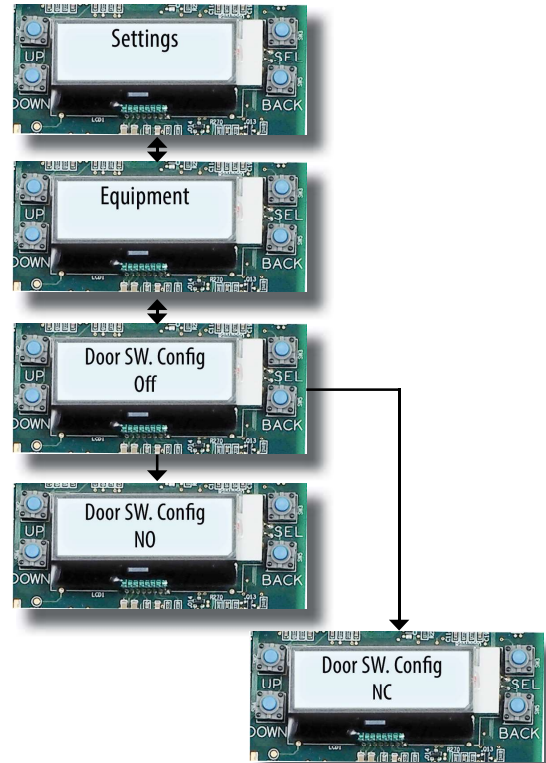

3. Normally Open (N.O) Door Switch

Active State→Closed contact: System runs.

Digital Input #1 (Door Switch Input) displayed on Status screen as ON.

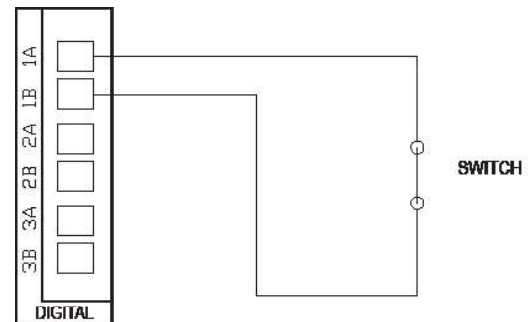

¹ Door Switch Feature available with controller software version HT-PG01-00-01-18 or newer.

Installation and Operations Manual

3. Normally Open (N.O) Door Switch continued

Inactive State→Open contact: System pumps down, fans turn off.

T003 Door Open Alert is generated.

Digital Input #1 (Door Switch Input) displayed on Status screen as OFF.

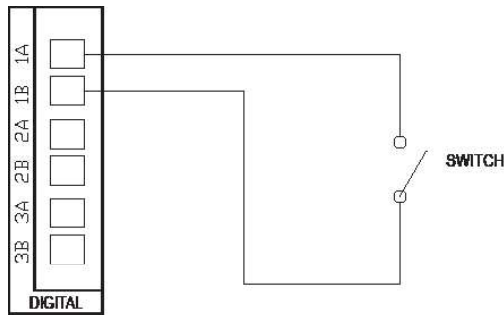

4. Normally Closed (N.C) Door Switch continued

Inactive State→Closed contact: System pumps down, fans turn off.

T003 Door Open Alert is generated.

Digital Input #1 (Door Switch Input) displayed on Status screen as ON.

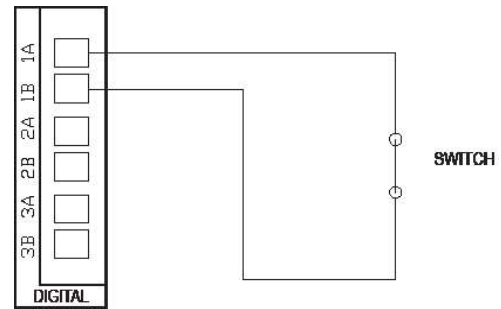

4. Normally Closed (N.C) Door Switch

Active State→Open contact: System runs.

Digital Input #1 (Door Switch Input) displayed on Status screen as OFF.

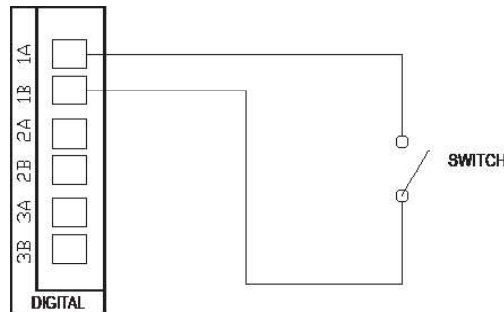

Configuring Door Switch Delay¹

Use the **UP/DOWN/SEL/BACK** buttons to navigate to **Settings→Equipment**.

Under Equipment, navigate to Door Sw. Time.

Press **SEL** button, default setting (0 sec) will start flashing. Use **UP** or **DOWN** buttons to adjust to desired delay. Press **SEL** button again to confirm change.

Default 0 second delay: system will pump down and fans turn off immediately when Door Open Alert is generated.

Delay can be configured for 30 seconds, 1 minute, 2 minutes, 3 minutes, 4 minutes or 5 minutes.

With Door Switch configured as N.O. or N.C., contact has to be in its inactive state continuously for the configured Delay time before Door Open Alert is generated, system pumps down and fans turn off.

¹ Door Switch Feature available with controller software version HT-PG01-00-01-18 or newer.

EcoNet® Enabled Unit Coolers

Configuring Door Switch Delay¹ continued

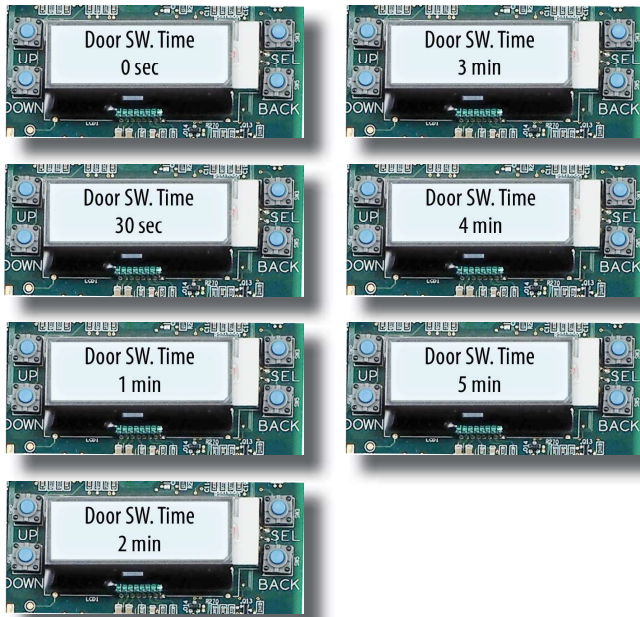

Door Switch Sequence of Operations¹

With Door Switch configured, T003 Door Open Alert will cause system to pump down and fans to turn off immediately when Digital Input is in its inactive state (open contact for N.O. or closed contact for N.C.).

With Door Switch configured as N.O. or N.C. and with a configured Delay, contact has to be in its inactive state continuously for the configured Time Delay before Door Open Alert is generated, system pumps down and fans turn off.

Once system pumps down and fans turn off, a 2 minute minimum off time is observed where the EXV will remain closed regardless of Door Switch Input status.

After Digital Input changes back to its active state and remains there for 5 seconds, the T003 Door Open Alert will clear and system will be allowed to run again.

If input changes back to its active state before the 2 minute minimum, fans will run at 50% speed. After the 2 minute minimum, cooling mode resumes (EXV opens, fans cycle to 100% speed).

If Door Open Alert is generated during a defrost cycle (Air or Electric), defrost cycle continues unaffected. There is a mandatory 5 minute minimum cooling period following the defrost cycle, regardless of Door Switch input status.

NOTE: The Door Open Alert does not reset the Space Temperature Alarm delay timer (set by Cmp. Max. Run Time under Settings), nor does it clear the "A108 Cooler/Freezer not Satisfying Setpnt. Alert" once it has been generated.

Door Switch Sequence in a Group¹

Only the group Leader needs the Door Switch wired and configured.

T003 Door Open Alert is generated at Leader when input is in inactive state for the configured Delay. Follower evaporators will receive pump down command from Leader and their fans will turn off.

Minimum 2 minute off time applies to entire Group. If Digital Input at Leader changes back to its active state before the 2 minutes are up, Leader and Followers will turn their fans to 50% after the Door Open Alert is cleared. After the 2 minutes have elapsed, Group resumes cooling as soon as the Door Open Alert has cleared.

If Door Open Alert is generated during a defrost cycle (Air or Electric), defrost cycle continues unaffected for the entire Group. There is a mandatory 5 minute minimum cooling period following the defrost cycle, regardless of Door Switch input status.

Door Open Alert does not clear "A108 Cooler/Freezer not Satisfying Setpnt. Alert" or reset its timer count.

Compressor Control (Packaged Refrigeration Units)²

The EcoNet Evaporator Controller can be set to cycle the compressor ON or OFF via Aux Relay 2 by configuring the Aux Relay Config. setting to *Comp-Fan Control*. The controller will use the Suction Pressure transducer reading to determine if the compressor needs to run. This setting is required for Packaged Refrigeration Units.

NOTE: Controller version HT-PG01-00-01-23 or newer is required for Packaged Refrigeration Unit configuration.

Relevant controller configurations for Packaged Refrigeration Unit compressor operation (see Parameters List on page 8 for complete list of configuration settings):

Configuration	Adjustment Range	Default Setting
Aux Relay Config.	Comp-Fan Control; Fan Control	"Comp-Fan Control"
Cut-Out Setpoint	-2 PSIG to 60 PSIG	"0 PSIG" for Freezer units;"20 PSIG" for Cooler units
Cut-In Offset	10 PSIG to 50 PSIG	"20 PSIG"

¹ Feature available with controller version HT-PG01-00-01-18 or newer

² Feature available with controller version HT-PG01-00-01-23 or newer

Installation and Operations Manual

Configuration settings (Navigate to [Settings](#)→[Equipment](#) on controller display to view/adjust):

1. Aux Relay Config.
 - a. *Comp-Fan Control*: Controller will use Auxiliary Relay 1 for Evaporator Fan ON/OFF control, and Aux Relay 2 for Compressor ON/OFF control based on Suction Pressure transducer reading.

NOTE: This setting only applies to Packaged Refrigeration Units. Packaged Refrigeration Units MUST be set to *Comp-Fan Control* or damage to equipment will result!



- b. *Fan Control*: Controller will use Auxiliary Relays 1 and 2 for Evaporator Fan ON/OFF control and fan speed control. **This setting is applicable for all other evaporator unit models. Not applicable for Packaged Refrigeration Units!**



2. Cut-Out Setpoint: Pressure setpoint at which the compressor will turn off when Aux Relay Config. Is set to *Comp-Fan Control*.



3. Cut-In Offset: Pressure differential for compressor to turn on when Aux Relay Config. is set to *Comp-Fan Control*.



Compressor Operation

When a cooling cycle starts, the controller will open the Electronic Expansion Valve (EEV) which will cause the Suction Pressure to increase.

The compressor will turn ON when:

Suction Pressure (PSIG) is greater than Cut-Out Setpoint + Cut-In Offset

To prevent compressor short cycling, the controller will keep the compressor on for a minimum amount of time while the EEV is open, even if the Suction Pressure briefly gets below the Cut-Out Setpoint.

When a cooling cycle ends (setpoint is satisfied, defrost starts, etc.) the controller will close the EEV. The Suction Pressure will decrease with compressor pumping down.

The compressor will turn OFF when:

Suction Pressure (PSIG) is less than the *Cut-Out Setpoint*

When there is no call for cooling (EEV is closed), the compressor will turn off immediately whenever the Suction Pressure drops below the *Cut-Out Setpoint*.

Example 1 (Low Temperature Unit):

Cut-Out Setpoint = 0 PSIG

Cut-In Offset = 20 PSIG

Compressor will turn ON when Suction Pressure is greater than 20 PSIG.

Compressor will turn OFF when Suction Pressure is less than 0 PSIG.

Example 2 (Medium Temperature Unit):

Cut-out Setpoint = 20 PSIG

Cut-In Offset = 20 PSIG

Compressor will turn ON when Suction Pressure is greater than 40 PSIG.

Compressor will turn OFF when Suction Pressure is less than 20 PSIG.

NOTE: If the unit is defrosting (air or electric), the controller will not allow the compressor to turn on. When the unit is not defrosting, the controller will allow the compressor to turn on for the next cooling cycle when the EEV opens, or for pump down if needed while the EEV is closed.

Defrost Heater Pump Down Delay¹

Configurable delay to allow compressor to pump down before electric heaters are activated at the start of a defrost cycle.

Default setting is "None"; Heater relays are activated as soon as EXV is closed.

Available delay configurations of 1, 2, 3, 4, or 5 minutes.

Only applicable when controller is configured as "Freezer"; delay will have no effect if controller is configured as "Cooler."

¹ Feature available with controller software version HT-PG01-00-01-18 or newer.

EcoNet® Enabled Unit Coolers

Configuring Defrost Pump Down Delay¹

Navigate to **Settings**→**Equipment** on controller display.

Scroll down to “Def.Pmp.Dn.Delay”

Press **SEL** button, default setting (None) will start flashing. Use **UP** or **DOWN** buttons to adjust to desired delay. Press **SEL** button again to confirm change.

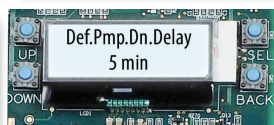
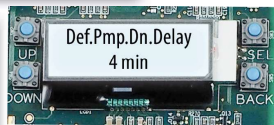
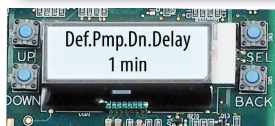

When “Defrosting” appears on display, the heater relays are active, and fans turn off.

After defrost terminates (time or temperature), drain time will follow as normal.

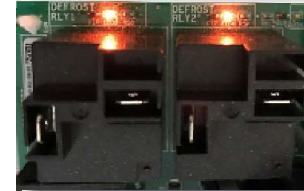

When defrost cycle starts, display will show “Initialize” for the duration of the delay. Fans cycle to 50% speed after EXV has closed.

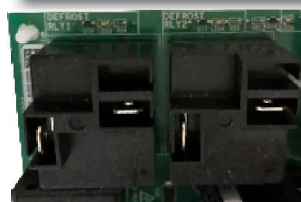

Installation and Operations Manual

Leak Detection¹

The EcoNet evaporator controller can be paired with a leak detection device to assist with mitigation procedures in case of a refrigerant leak.

NOTE: THIS FEATURE IS INTENDED FOR USE WITH A2L REFRIGERANTS (R454A, R454C, R455A). REQUIRES INSTALLATION OF A LIQUID LINE SOLENOID VALVE UPSTREAM, AND A SUCTION LINE CHECK VALVE DOWNSTREAM OF THE EVAPORATOR TO INTERRUPT REFRIGERANT FLOW WHEN A LEAK IS DETECTED.

Wiring the Leak Detector Device to the EcoNet Controller

Wire the leak detector device to Digital Input #2 (terminals 2A and 2B) using 18-20 AWG wire.

Input is a dry contact; no external voltage source needed.

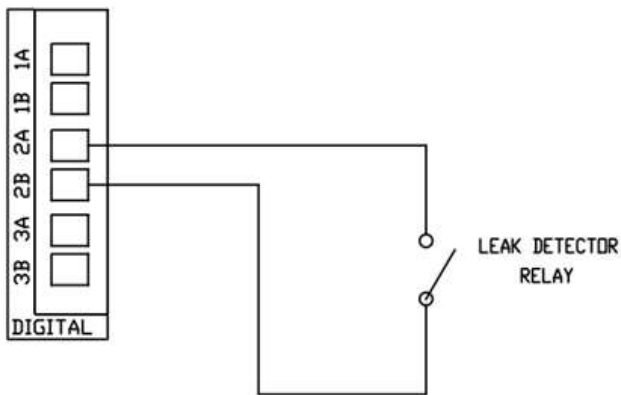

Normally Open (N.O.) Leak Detector Relay

Active State → Closed Contact: Leak Alarm Active. "A004 Refrigerant Leak Detect Alarm" generated. Digital Input #2 displayed on Status screen as ON.

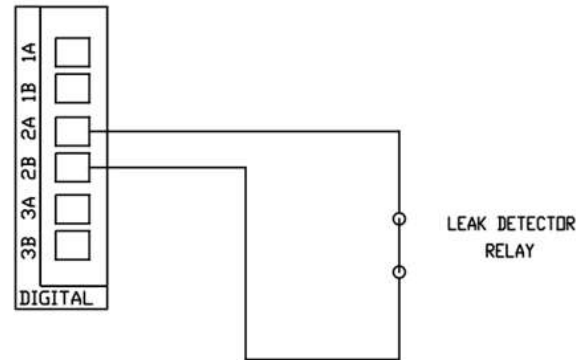

Inactive State → Open Contact: System runs. Digital Input #2 displayed on Status screen as OFF.

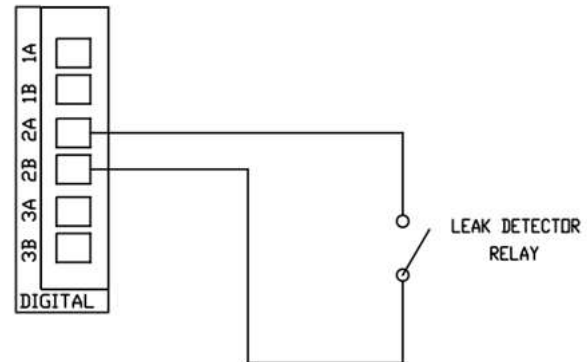

Configuring the Leak Detector Input

Use the UP/DOWN/SEL/BACK buttons to navigate to [Settings → Equipment](#)

Under Equipment, navigate to Leak Sw. Config.

Press SEL button, default setting (Off) will start flashing.

Use UP or DOWN buttons to adjust to desired leak detector input operation.

Press SEL button again to confirm change.

Default setting is "Off"; can be configured as Normally Open (N.O.), or Normally Closed (N.C.).

Normally Closed (N.C.) Leak Detector Relay

Active State → Open Contact: Leak Alarm Active. "A004 Refrigerant Leak Detect Alarm" generated. Digital Input #2 displayed on Status screen as OFF.

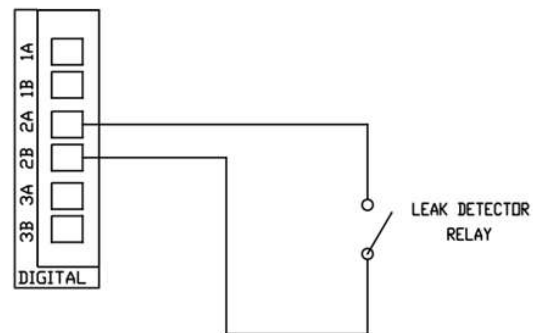

¹ Feature available with controller software version HT-PG01-00-01-25 or newer.

EcoNet® Enabled Unit Coolers

Inactive State → Closed contact: System runs. Digital Input #2 displayed on Status screen as ON.

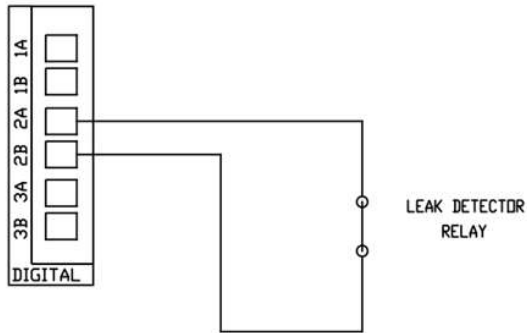

When the leak detection input (Digital Input #2) becomes active, the EcoNet controller shall do the following:

1. Keep evaporator fans turned on.
2. Electronic Expansion Valve will stay at an open position.
(Installation of solenoid and check valves required on liquid and suction lines)
3. Controller display will read "Leak Alarm Active"
4. "A004 Refrigerant Leak Detect Alarm" will appear on the active alarm screen and logged in the alarm history.
5. If Aux Relay Config. is set to Comp-Fan Control (Packaged Refrigeration Units), the Aux Relay #2 for the compressor will remain OFF.

The leak alarm condition will stay on for as long as Digital Input #2 is in its active state. If the leak detection input becomes active while the controller is undergoing a defrost cycle, the defrost cycle will be suspended.

NOTE: The leak alarm condition will also override the Door Switch and System Enable functions.

When Digital Input #2 becomes inactive, the controller will wait 10 seconds before resuming normal operation.

On group operation, each group member will generate a leak alarm only when their own individual leak detector input (Digital Input #2) becomes active.

When a group member generates a leak alarm, that group member will follow the steps described above. Other group members will also display "Leak Alarm Active" on their display screens but may continue their refrigeration functions if their respective leak detector inputs are not active.

Operational Limits

1. Voltage: 115V/230V
2. Operating Temp range: -40°F to 122°F
3. Operating Humidity range: 0% to 97% RH condensing
4. Groups/Leaders/Members: 32 devices max on daisy chain; 1000 ft. max length from first device to last device on daisy chain
5. Defrost Relay #1: 24A at 240VAC
6. Defrost Relay #2: 24A at 240VAC
7. Aux Relay #1: 3A at 120VAC
8. Aux Relay #2: 3A at 120VAC

Replacement Parts/Numbers

1. Control Boards (08219624)
2. Sensors
 - a. Space/Drain Temp (08219623)
 - b. Evap Temp (08219636)
 - c. Suction Temp (08219637)
 - d. Suction Pressure (08219621)
3. Wire Harness
 - a. 63" Controller wire harness, SER valve (0821963501)
 - b. 96" Controller wire harness, SER valve (0821963502)
 - c. 126" Controller wire harness, SER valve (0821963503)
4. Controller Power Harness (08219638)

For help with replacement parts, e-mail or call our Parts Department at: parts@htpg.com or 1-855-HTPARTS (1-855-487-2787)

Installation and Operations Manual

EcoNet Command Center (if equipped)

The HTPG EcoNet Command Control Center is an intelligent device that provides remote local control over HTPG EcoNet enabled evaporators in cooler or freezer applications. It's designed to be simple to operate with an intuitive touchscreen interface for seamless control of both groups and standalone systems.

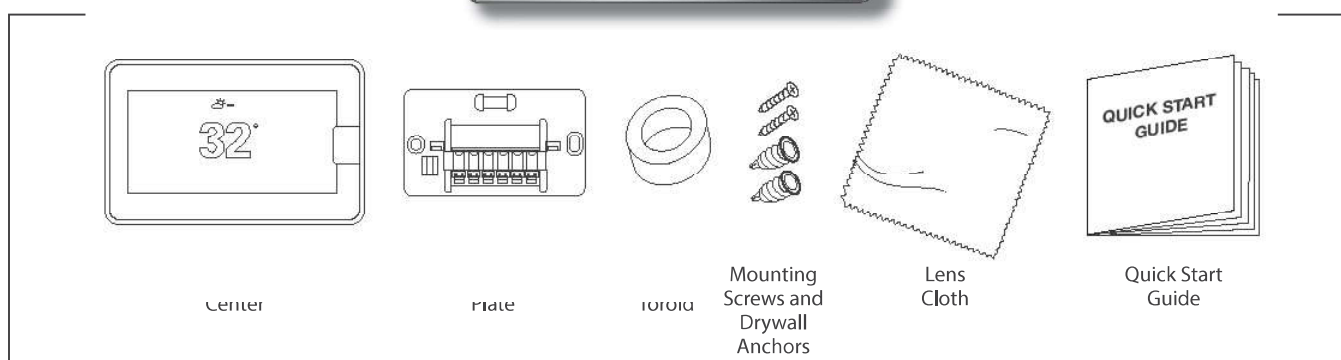

Center

Plate

Tape

Mounting
Screws and
Drywall
AnchorsLens
ClothQuick Start
Guide

Safety Considerations

Failure to read and follow all instructions carefully before installing or operating this control and system could cause personal injury and/or property damage.

NOTE: All wiring must comply with national, local, and state codes.

WARNING: Power off your refrigeration system by using the master switch or circuit breaker box. Verify that power is not present before beginning installation.

Only a trained service professional/contractor should use or interact with the control board.

Control Mounting Location

The EcoNet Command Center is an intuitive touchscreen interface allowing complete control of individual and grouped EcoNet Enabled Unit Coolers. This advanced unit provides a single interface to conveniently manage everything from temperature to the most advanced system settings of all EcoNet Enabled coolers and freezers on the EcoNet communication bus. It should be mounted indoors outside the cooler enclosure and located where it is easily accessible and visible to the business end user. Avoid mounting in high humidity areas.

Installation Instructions

The EcoNet System consists of several intelligent, communicating components. Commands, operating conditions, and other data is passed continuously between components. All system components can be controlled through the wall mounted EcoNet Command Center providing the user with a single interface to manage all features of the system.

The EcoNet Command Center remembers the system configurations of all connected equipment. If the EcoNet Command Center needs to be removed or replaced the refrigeration system will continue to operate normally and will keep its configuration settings.

When connecting multiple standalone evaporator units to the EcoNet network with a Command Center, use the "Network Instance" parameter ([Settings](#)→ [Equipment](#)→[Network Instance](#)) to address each of them at the board display before connecting them to the daisy chain communication bus (see page 8 for Parameters List). When connecting evaporator units that will operate as a group, use the "Group Member Cfg" parameter ([Settings](#)→[Equipment](#)→[Group Member Cfg](#)) to address each group member at the board display before connecting them to the daisy chain communication bus (see Page 8 for Parameters list, page 15 for Group Operation). Multiple Standalone units and Group units can be combined on the same daisy chain network with the Command Center, as long as the wiring guidelines are followed (see page 17). A maximum of 32 devices can be wired on the network, with a maximum 1,000 feet wire length from first

EcoNet® Enabled Unit Coolers

device to last device. The Command Center counts as one device and can be wired on either end of the network (see Figure 11 on page 26 for wiring diagram example). If the Command Center will be connected to Wi-Fi for Web Portal use, then a maximum of 9 devices can be wired on the network (Command Center plus 8 evaporator controllers). Please see Web Portal IOM for more information.

NOTE: Read the entire instruction manual before starting the installation.

Operating conditions for the EcoNet Command Center: 0°C to 70°C (32°F to 158°F), 95% RH, Non-Condensing.

Wiring Considerations

The EcoNet Command Center can be powered using only 18AWG shielded wire from the EcoNet control board up to 150 feet away. Wire should be free from defects such as wear, cracks or anything that would hinder the conductivity of the wire within the circuit.

NOTE: If the 16V power wires are shorted the unit cooler board will shut down and cease operation until the short is corrected.

If the Command Center wiring will be located near or in parallel with high voltage wiring, cable TV, Ethernet wiring or radio-frequency equipment, then shielded thermostat wire can be used to reduce or eliminate potential interference. The shield wire should be connected to the evaporator unit earth ground. The shield wire should not be connected to the controller PCB. The shield wire from all runs should be attached together and

only grounded at one evaporator unit. The shield wire should not be connected to any terminal at the Command Center. Connecting the shield to ground at more than one location can cause current loops in the shield, reducing shield effectiveness.

For distances over 150 feet an external isolated power supply is required and will be connected to the R and C terminals of the EcoNet Command Center. An AC/DC wall mount adapter supply with a rating of 9V or 12V and 400mA or greater is acceptable. The EcoNet communication terminals (E1 and E2) can be wired using ordinary thermostat wire.

NOTE: Wiring only requires four wires. However, it is good practice to run cable having more than four wires in the event of a damaged or broken wire during installation.

Maximum wiring length of communication bus from first device to last device is 1,000 feet.

The units should be wired in a “daisy chain” and not in a “star” configuration (see Figure 11 on page 26). To “daisy chain” the units on the network, each unit should have a set of wires coming into it and one set going out of it. The devices on the ends should have only one set of wires running to them. The order of the devices in the network is not important. The EcoNet Command Center has a six-terminal connectors labeled R, C, E1, E2, S1 and S2. The S1 and S2 terminals will never be used in this application.

CONTROLLER COMMUNICATIONS WIRING

Terminal	Function
R	Power - 24 VAC or 9-21 VDC
C	Common/Ground - 24 VAC
E1	EcoNet Communications Bus Wire 1
E2	EcoNet Communications Bus Wire 2

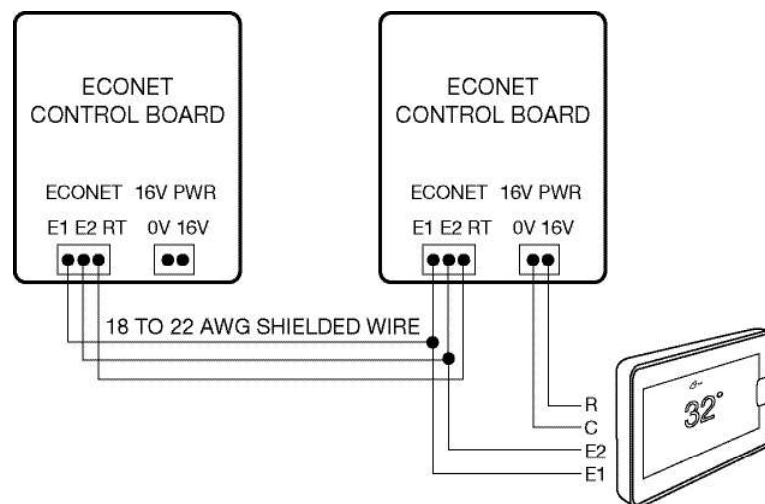

Figure 10

See Figure 11 on page 26 for typical wiring configuration with multiple controllers.

User Guide

System Mode

The EcoNet Command Center can be used to control cooler or freezer applications.

Homescreen Overview



If multiple evaporators are wired to the network with the Command Center, select the "UNITS" tab on the lower right corner to navigate back and forth through the various units or groups currently active in the network. The Selected Unit will be displayed in the Home Screen with its current Space Temperature and Setpoint. If only one evaporator is connected to the Command Center, the "UNITS" tab will not appear.

Assign Name to Unit/Group¹

At the homescreen, touch and hold the Unit/Group line for 5 seconds to assign a custom name. A keyboard screen (see below) will appear for the user to manually enter a custom name for the system (i.e. Freezer #1, Meat Cooler, etc.), then hit the Save button to confirm the name entry. The new custom name will be displayed on the homescreen under the Unit/Group number. Each Unit or Group connected to the Command Center can be assigned its own custom name for easier identification.



Settings

Menu Options

Tap the Menu icon in the bottom left corner of the home screen to easily configure basic and system level settings and view equipment status.



Settings (Menu > Settings)

Adjust system-level settings, preferences and time.

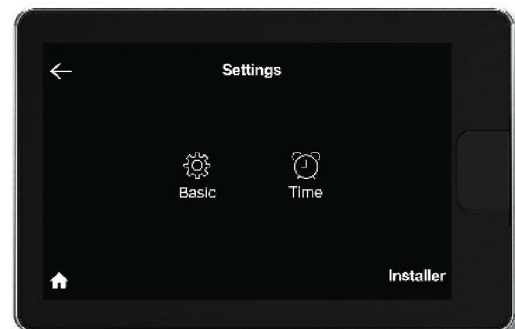

¹ Feature available with Command Center version HT-H1RM-00-01-05 or newer.

EcoNet® Enabled Unit Coolers

Basic (Menu > Settings > Basic)

Adjust basic settings for the local Control Center.

Alarm Beep Enable: Sounds an audible alarm tone shall a critical alarm condition occur.

Screen Lock: To lock the main screen from any changes, enable screen lock. To unlock, enter the Basic settings menu again and set Screen Lock to "No." This locking function prevents any changes except changes made from within the Basic Settings.

Temperature Display: Changes the displayed space temperature and set points between Fahrenheit and Celsius.

Proximity Sensing: This enables the Command Center screen to go into standby mode after a short period of inactivity. The screen will wake up when the Command Center proximity sensor detects motion near the screen. If Proximity Sensing is disabled, the motion sensing is not used and the user will have to touch the screen to wake up the display.

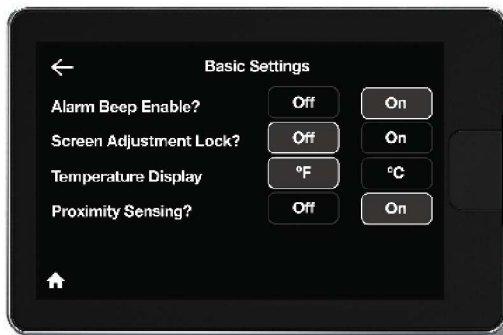

Time and Date (Menu > Settings > Time)

Set the current time and date. Alerts and Alarms will be date and time stamped so it is important the clock is programmed correctly. This configuration only needs to be done once after all the controllers are addressed and connected together; the Command Center will broadcast the new time and date settings to all the controllers connected to the EcoNet network.



DST: At the bottom of this screen you can elect to enable or disable daylight savings time. Enabling this setting will automatically update the clock for Daylight Savings.



Status (Menu > Status)

Tapping **Menu > Status** will display the equipment operating status for the selected EcoNet control board. Use the left < or right > symbols to quickly navigate between control units.



Installation and Operations Manual

Service (Menu > Service)

Tapping **Menu > Service** from the home screen will display current alarms, alarm history, support contact information, equipment info, test options and network.



Current: Shows currently active alerts and or alarms. When an equipment alert or alarm is present, an alert-alarm icon will appear on the home screen, and the alarm beep will sound if enabled. Select the alert-alarm icon on the home screen to quickly view the alert or alarm and a brief description.



History: Shows a list of the past eight alerts/alarms with the time and date stamp.



Support: Allows you to input the contact information for your preferred contractor or install professional (company name, phone number and email address), so that it's always available should you run into any issues. Simply use the on-screen keyboard to enter the appropriate contact information.

NOTE: You should always contact your preferred contractor or install professional regarding alerts/alarms, performance issues or other questions specific to your equipment.

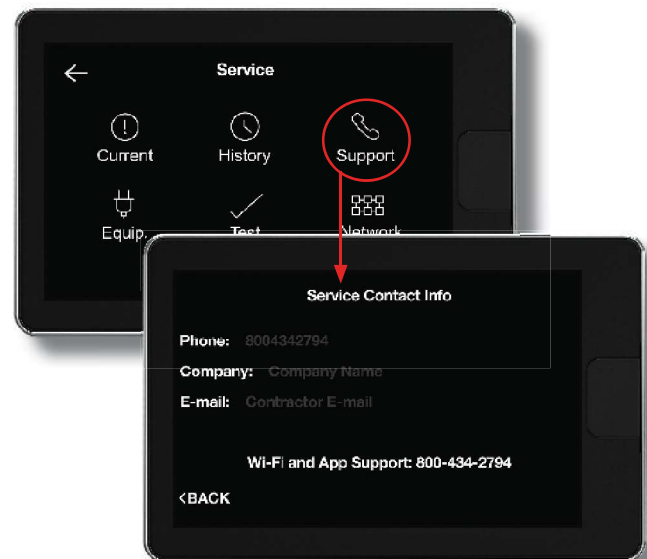

Equip.: Displays the model, serial number and software version of all the connected equipment on the EcoNet communication bus.

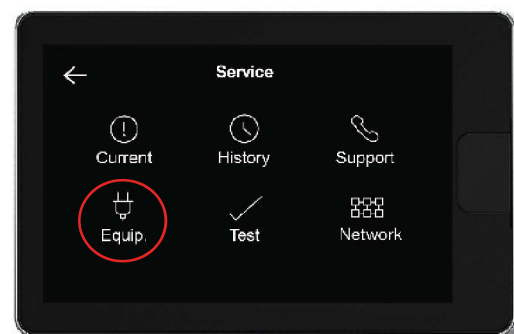

EcoNet® Enabled Unit Coolers

Test: The Test option will allow the user to run a manual defrost cycle. In group configurations the manual defrost command through EcoNet Command Center is only available for Group Leaders. Followers will start the defrost simultaneously.

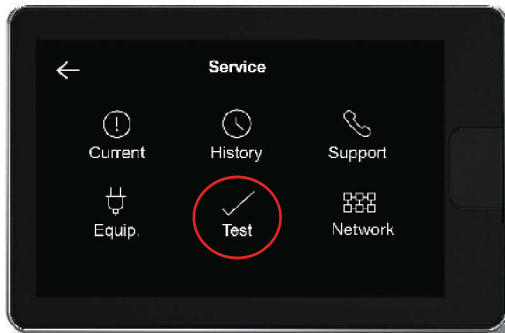

Network: Displays all of the connected units on the EcoNet communication bus. Easily see group configurations and standalone units on one screen.

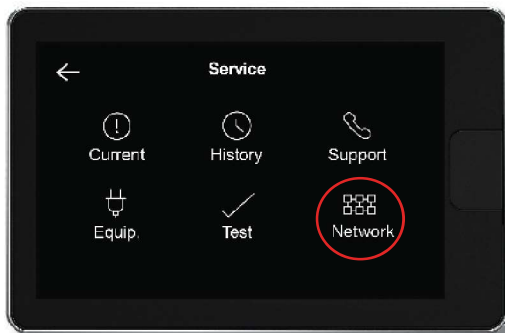

Loss of Communication with Controller¹: The Command Center Display is continuously monitoring communication status with any controller connected to the daisy chain network, and will learn of any new addressed controllers as soon as they are connected. If a previously connected controller loses communication with the Command Center (due to loss of power, or disconnected wire), the Command Center Display will stop showing temperature status at the home screen for that device (see first image below), and will also show that device grayed out on the Network Screen under the Status Menu (see second image below). As soon as the device is reconnected, the Command Center will resume communication with the device.

NOTE: Power cycling the Command Center will cause it to start over and re-learn all the devices on the network.

¹ Feature available with Command Center version HT-H1RM-00-01-05 or newer.



Caring for your Smart Refrigeration Control

Cleaning

You can clean your control screen by lightly spraying water on the provided lens cloth or a clean microfiber cloth. Wipe the surface of the screen with the dampened cloth. It is recommended you first lock the screen ([Menu > Settings > Basic > Screen Lock](#) set to "Yes").

NOTE: Never spray any liquids directly onto your EcoNet Command Center.

Rebooting

You can reboot your EcoNet Command Center by cycling power to the device. Rebooting will not alter programming, settings or configuration options.

Installation and Operations Manual

Installer Settings

Installer Settings Defaults

Object	Range	Default	Description
System Enabled	No/Yes	Yes	If the user desires to temporarily disable the system without disconnecting power to the unit select "No"
Run Time Until Defrost	0 to 900 Minutes	360 Minutes	Set to configure the allowed compressor runtime before the unit goes into defrost when controller is set to Timed defrost
Defrost Max Run Time	10 to 60 Minutes	60 Minutes	Set to configure the maximum allowed defrost time
EXV Superheat Set Point	4.0°F to 20.0°F	6.5°F	Set to configure desired superheat set point
Comp. Run Time Alert	0 to 480 Minutes	120 Minutes	Set to configure the allowed compressor runtime until Space Temperature Alarm is generated. If unit is actively cooling the space continuously for longer than this time period, an alarm will be generated to indicate that box has not achieved set point
Def. Term. Temp ¹	35 °F to 65 °F	55 °F (Freezer); 40 °F (Cooler)	Set to configure the Defrost Termination Temperature; the temperature that the Evaporator has to reach in order to terminate the defrost cycle
Def. Pulse Overr. ¹	Yes or No	No	Set to override the pulsing function of Defrost Relay 1 (Top Heater on a Low Profile Evaporator)
Set Point Hysteresis	0.5°F to 20.0°F	2.0°F	Set to configure desired hysteresis range for space temperature control. When the space temperature rises above the set point by the hysteresis value the system will generate a call for cooling
Cooler/Freezer Select	Cooler or Freezer	Freezer ¹	Set the controller for the type of operation it will be used in
Refrigerant Used	R448A, R407A, R407C, R449A, R404A, R507A, R513A, R450A	R448A	Set the refrigerant that will be used in the system
Evaporator Coil Type	Single or Dual	Single	Set for the type of evaporator being used. "Single" applies to Low Profile evaporators. "Dual" applies to dual coil designs such as Center Mount evaporators, where Evap Temp 2 sensor is used
Drain Sensor Installed	No/Yes	No	Set to "Yes" if a drain temp sensor is installed
Aux Sensor Installed	No/Yes	No	Set to "Yes" if an auxiliary sensor is installed
EXV Stepper Type	480 to 2500 Steps	2500 Steps	Set to configure EXV type; 2500 steps or 480 steps. This should come preset from the factory and should not be changed
Defrost. Pump Down Delay ²	none/1 min/2 min/3 min/4 min/5 min	none	Set desired delay for pump down before electric heaters become active at the start of a defrost cycle. NOTE: This parameter only affects units that are set to Freezer. See Defrost Heater Pump Down Delay section for more information.
Defrost Type ⁴	Timed/Adaptive	Timed	Select desired defrost algorithm: Timed or Adaptive. NOTE: This only applies if controller is set to Freezer. If controller is set to Cooler, Timed defrost will always remain as the functional setting.

EcoNet® Enabled Unit Coolers

Run Time Adapt. Defrost ⁴	360 to 900 minutes	720 minutes	Set to configure the allowed compressor runtime before the unit goes into defrost when controller is set to Adaptive defrost.
Door Switch Config. ²	Off-NO-NC	Off	Configure Door Switch function as Normally Open (N.O.), or Normally Closed (N.C.) to enable Digital Input #1 to be used as contact for a door switch. See Door Switch section for more information.
Door Switch Alert Time ²	0 sec/30 sec/1 min/2 min/ 3 min/4 min/5 min	0 sec	When Door Switch is configured to N.O. or N.C., use this parameter to set desired delay to pump down the system when the Door Switch input (Digital Input #1) becomes inactive.
Comp. Minimum Run Time ³	3 min/4 min/5 min	5 min	Adjust the minimum compressor run time for each cooling cycle. When refrigeration mode starts (EXV opens), the system will run for the minimum time that has been set. After this minimum time has elapsed, controller will pump down the system if Setpoint has been satisfied.

NOTE: Parameter will be automatically selected by the EcoNet Command Center by detecting factory settings of the EcoNet Enabled Unit Cooler. For optimal performance, the factory setting should not be changed. A trained service professional/contractor may override the auto-populated default if necessary.

¹ Feature available with controller software version HT-PG01-00-01-13 or newer.

² Feature available with controller software version HT-PG01-00-01-18 or newer.

³ Feature available with controller software version HT-PG01-00-01-21 or newer.

⁴ Feature available with controller software version HT-PG01-00-01-22 or newer.

Recommended Settings

1. Low Profile Evaporators
 - a. Coil Type: Single
 - b. Defrost Termination Temperature: 55°F for Freezers (electric defrost), 40°F for Coolers (air defrost).
 - c. Defrost Pulse Override: Yes or No for Freezers (electric defrost), depending on user preference/box conditions; not applicable for Coolers (air defrost).
2. Center Mount Evaporators
 - a. Coil Type: Dual
 - b. Defrost Termination Temperature: 40°F for Freezers (electric defrost); 40°F for Coolers (air defrost).
 - c. Defrost Pulse Override: Yes for Freezers (electric defrost); not applicable for Coolers (air defrost).

installer settings. Tap the < and > symbols to navigate between different units.

Note: If multiple standalone evaporators will be wired to the Command Center, each evaporator must be addressed individually at the controller display via the "Network Instance" parameter. If multiple evaporators will be wired to the Command Center to work as a group cooling the same space, each evaporator must be addressed individually at the controller display via the "Group Member Cfg" parameter.

The previous < and next > symbols around the unit or group selection can be used to quickly cycle through all of the units on the EcoNet bus to easily change settings.

System Enabled: Allows user to temporarily disable the system without disconnecting power to the unit. This function forces system pump down (EXV closes) and the fans turn off. The sensor inputs (temperatures, pressure, etc.) are still functional and can be viewed on the display.



Installer Settings

(Menu > Settings > Installer)

To enter the Installer Settings menu, select [Menu > Settings](#), then tap and hold on "Installer" on the bottom right of the screen for five seconds. Use the large left and right arrows to navigate

Installation and Operations Manual

Run Time Until Defrost: Set to configure the allowed compressor runtime before the unit goes into defrost.



Defrost Max Run Time: Set to configure the maximum allowed defrost time.

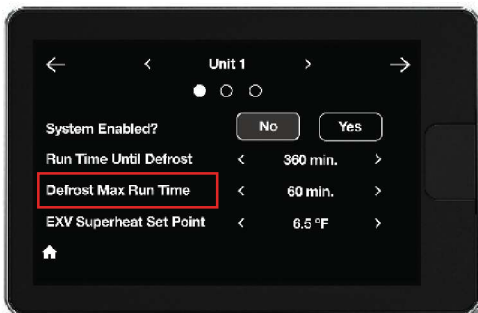

EXV SH Set Point: Set to configure desired superheat setpoint.

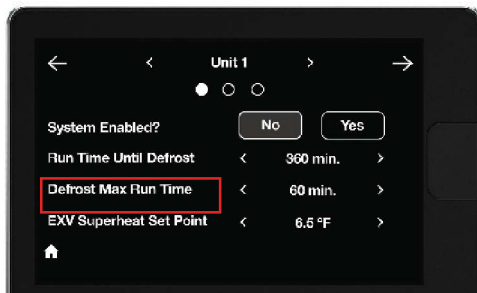

Def. Term. Temp¹: Sets the Defrost Termination Temperature.

NOTE: If the Cooler/Freezer parameter is manually adjusted, the Defrost Termination Temp setting will revert back to default (55 °F for Freezer, 40 °F for Cooler); if a value other than default is desired, make sure that Cooler/Freezer is set prior to adjusting the Defrost Termination Temperature.

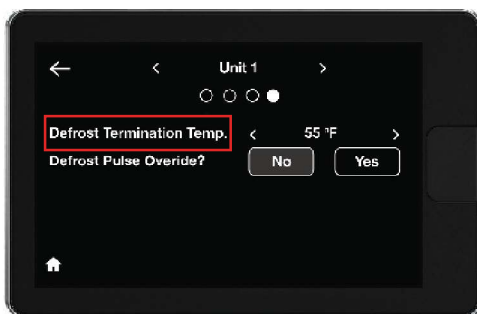

Def. Pulse Overrr¹: Allows the user to override the pulsing function of Defrost Relay 1 (Top Heater on a Low Profile Evaporator). If the override of the Defrost Relay 1 pulsing is not desired, set to "No" (Relay 1 will pulse). If overriding the pulsing is desired, set to "Yes"; the Defrost Relay 1 will remain energized for the duration of the defrost cycle (Relay 1 will NOT pulse).

NOTE: Def. Pulse Overrr. must be set to "Yes" on Center Mount, dual coil evaporators for proper defrost performance.

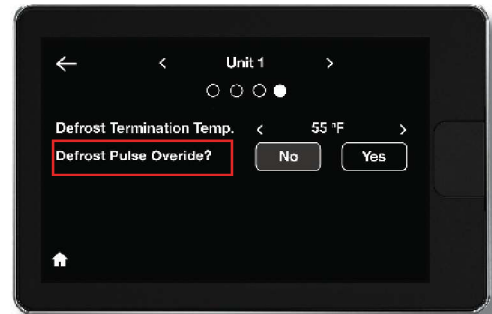

Comp. Run Time Alert: Set to configure the allowed compressor runtime until Space Temperature Alarm is generated. If unit is actively cooling the space continuously for longer than this time period, an alarm will be generated to indicate that box has not achieved set point.

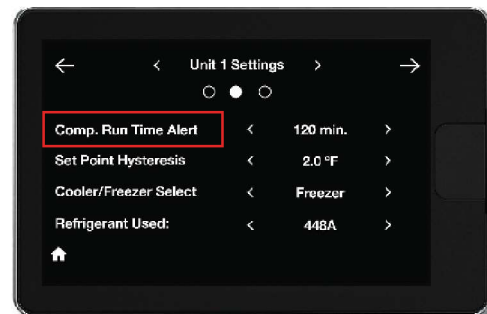

Set Point Hysteresis: Set to configure desired hysteresis range for space temperature control. When the system is in Refrigeration mode, if the Space Temp set point is -10°F with a default set point control differential of 2.0 dF, the unit will continue to cool the space until the Space Temp is just under -10°F. At this point, the system will pump down and run the fans at half speed. When the Space Temp rises to around -8°F, Refrigeration mode will start back up: EXV will open and the fans will run at full speed until set point is reached again or the unit goes into defrost.

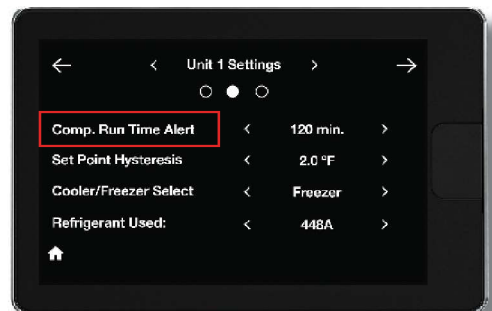

¹ Feature available with controller software version HT-PG01-00-01-13 or newer.

EcoNet® Enabled Unit Coolers

Cooler/Freezer Select: Set the controller for the type of operation it will be used in. If set as "Freezer", the controller will use the defrost relays to activate the electric heaters in the evaporator, and allow a drain time at the end of the defrost cycle. If set as "Cooler", the unit will operate as air defrost (off-cycle).

NOTE: Parameter will be automatically selected by the EcoNet Command Center by detecting factory settings of the EcoNet Enabled Unit Cooler. For optimal performance, the factory setting should not be changed. A trained service professional/contractor may override the auto-populated default if necessary.



Refrigerant Used: Set the refrigerant that will be used in the system from among the list of supported refrigerants. Default is R448A.

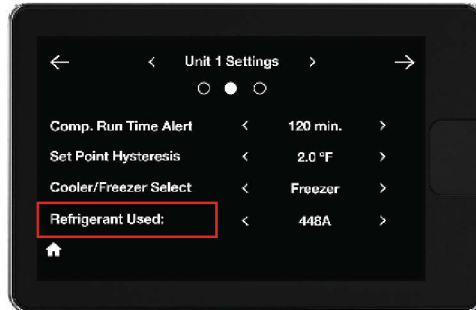

Evaporator Coil Type: Set for the type of evaporator being used. "Single" applies to Low Profile evaporators. "Dual" applies to dual coil designs such as the Center Mount evaporators, where Evap Temp 2 sensor is used.

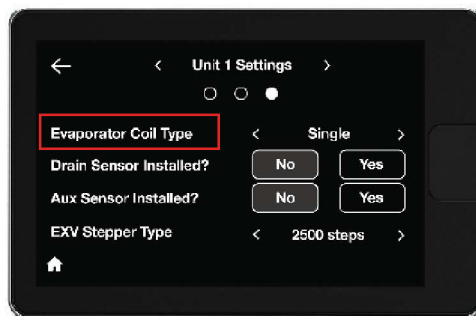

Drain Sensor Installed: Set to "Yes" if drain temp sensor is installed.

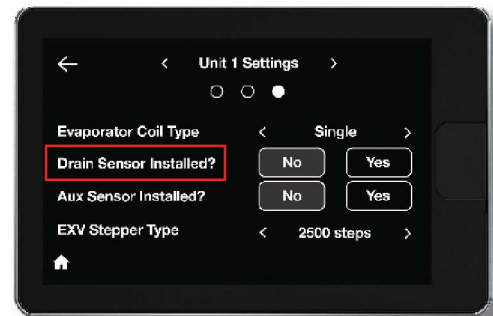

Aux Sensor Installed: Not used.

EXV Stepper Type: Set to configure EXV type; 2,500 steps or 480 steps. This should come preset from the factory and should not be changed.

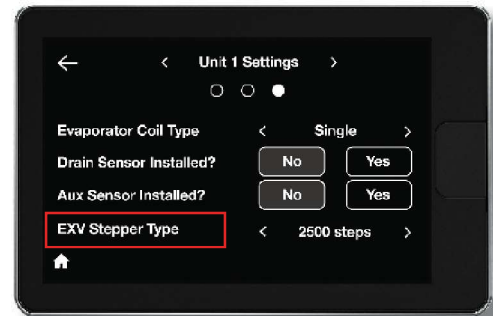

NOTE: Followers in a group configuration will not be able to adjust the following settings as these are configured by the leader:

- System Enabled
- Run Time Until Defrost
- Comp. Run Time Alert
- Set Point Hysteresis
- Cooler/Freezer Select
- Refrigerant Used
- Defrost Pump Down Delay
- Defrost Type
- Run Time Adapt. Defrost
- Door Switch Config.
- Door Switch Alert Time
- Comp. Minimum Run Time

Installation and Operations Manual

Typical Wiring Configuration with Multiple Controllers and Command Center

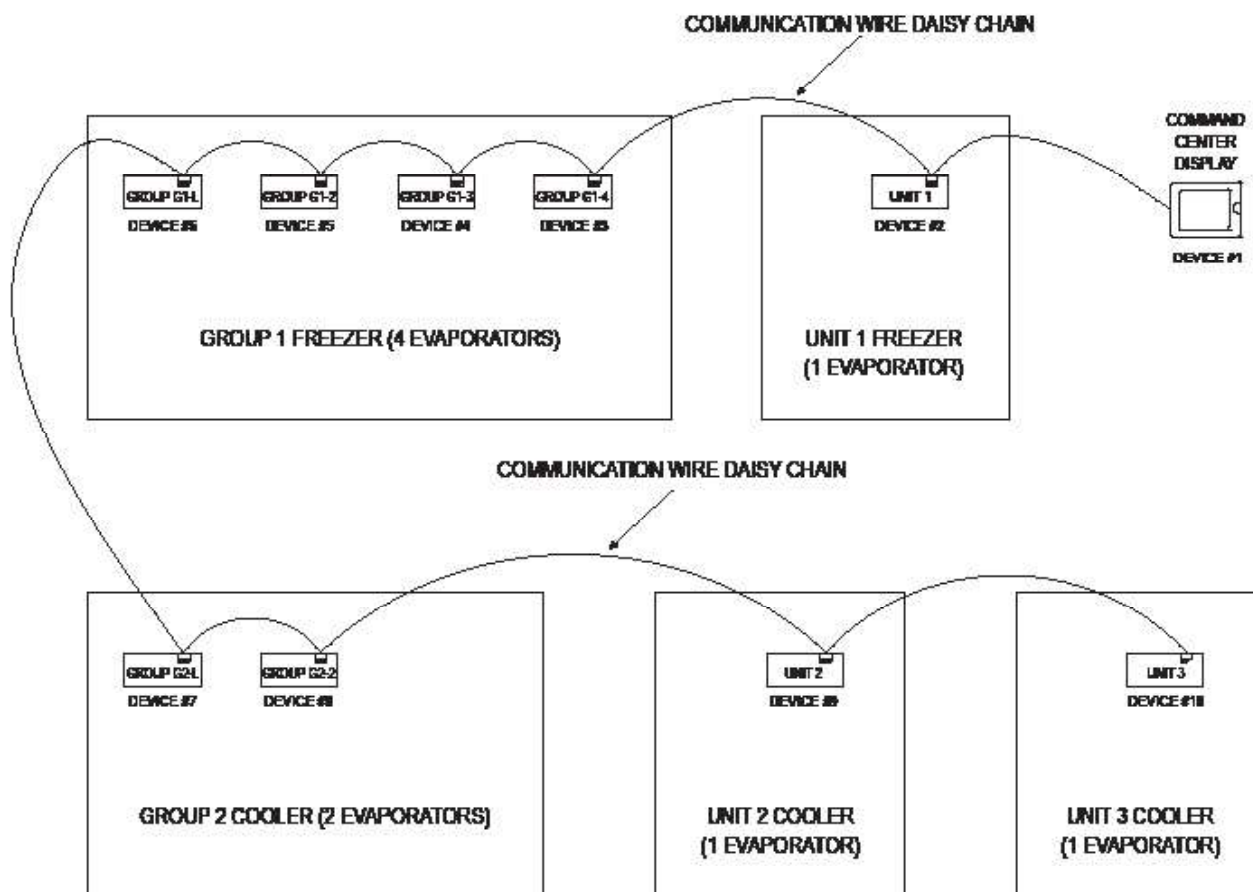

Figure 11

NOTES

- 1,000 feet maximum bus wire from first device to last device.
- 32 maximum number of devices (including the EcoNet Command Center) connected to same bus.
- If the Command Center is being connected to a network consisting of more than one EcoNet Controller, please make sure that all controllers are properly addressed and wired to the network before connecting the Command Center to said network.
- See Figure 10 on page 18 for controller communications wiring.

Installation and Operations Manual

Typical Wiring Configuration with Multiple Controllers without a Command Center

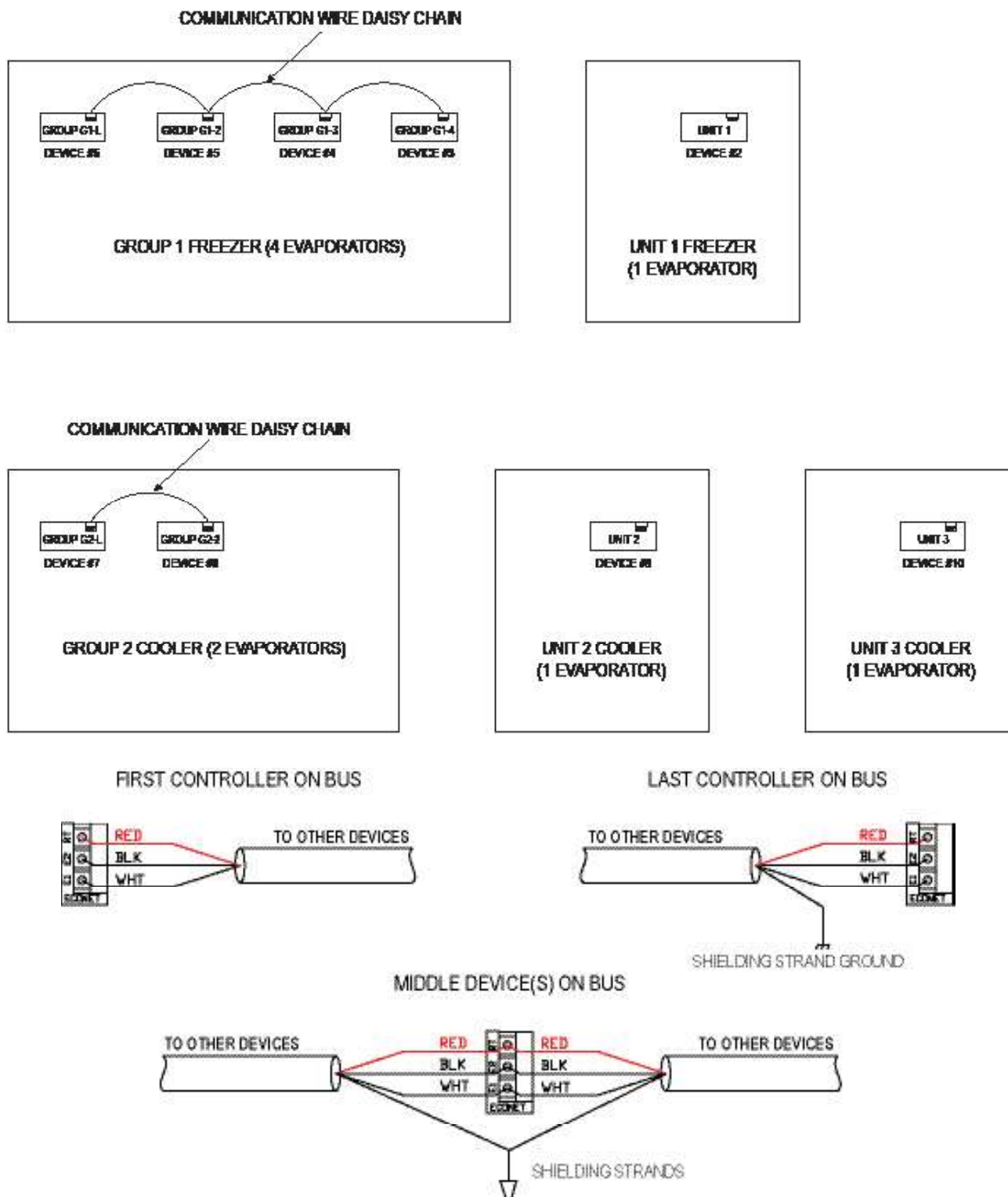

Figure 12

See notes on page 28

Due to continuing product development, specifications are subject to change without notice.

EcoNet® Enabled Unit Coolers

Part no. 8219636

Addendum

Evap Temp Thermistor Resistance Table

Fahrenheit	Kilo-Ohms	Fahrenheit	Kilo-Ohms	Fahrenheit	Kilo-Ohms	Fahrenheit	Kilo-Ohms
-40	346.62	-4	99.20	33	32.22	69	12.24
-39	335.84	-3	96.44	34	31.39	70	11.96
-38	325.06	-2	93.68	35	30.57	71	11.68
-37	314.28	-1	90.92	36	29.75	72	11.40
-36	303.50	0	88.16	37	28.92	73	11.12
-35	292.71	1	85.41	38	28.10	74	10.84
-34	281.93	2	82.65	39	27.28	75	10.56
-33	271.15	3	79.89	40	26.46	76	10.28
-32	260.37	4	77.13	41	25.63	77	10.00
-31	249.59	5	74.37	42	25.01	78	9.78
-30	242.04	6	72.36	43	24.39	79	9.56
-29	234.49	7	70.35	44	23.77	80	9.35
-28	226.95	8	68.33	45	23.15	81	9.13
-27	219.40	9	66.32	46	22.52	82	8.91
-26	211.85	10	64.31	47	21.90	83	8.69
-25	204.30	11	62.30	48	21.28	84	8.48
-24	196.76	12	60.29	49	20.66	85	8.26
-23	189.21	13	58.27	50	20.04	86	8.04
-22	181.66	14	56.26	51	19.57	87	7.87
-21	176.32	15	54.78	52	16.29	88	7.70
-20	170.98	16	53.30	53	16.22	89	7.53
-19	165.63	17	51.82	54	16.14	90	7.36
-18	160.29	18	50.34	55	16.07	91	7.19
-17	154.95	19	48.86	56	16.00	92	7.02
-16	149.61	20	47.38	57	15.93	93	6.85
-15	144.26	21	45.90	58	15.86	94	6.68
-14	138.92	22	44.42	59	15.78	95	6.51
13	133.58	23	42.94	60	15.42	96	6.37
-12	129.76	24	41.84	61	15.06	97	6.24
-11	125.94	25	40.74	62	14.70	98	6.10
-10	122.12	26	39.64	63	14.33	99	5.97
-9	118.30	27	38.54	64	13.97	100	5.83
-8	114.48	28	37.44	65	13.61	101	5.70
-7	110.66	29	36.34	66	13.25	102	5.57
-6	106.84	30	35.24	67	12.88	103	5.43
-5	103.02	31	34.14	68	12.52	104	5.30

Installation and Operations Manual

Part no. 8219623

Space/Drain Temp Thermistor Resistance Table

Fahrenheit	Kilo-Ohms	Fahrenheit	Kilo-Ohms	Fahrenheit	Kilo-Ohms	Fahrenheit	Kilo-Ohms
-40	169.16	-4	48.61	33	15.93	69	6.11
-39	163.89	-3	47.27	34	15.52	70	5.97
-38	158.63	-2	45.92	35	15.12	71	5.83
-37	153.37	-1	44.58	36	14.71	72	5.69
-36	148.11	0	43.23	37	14.31	73	5.55
-35	142.84	1	41.89	38	13.91	74	5.42
-34	137.58	2	40.54	39	13.50	75	5.28
-33	132.32	3	39.19	40	13.10	76	5.14
-32	127.06	4	37.85	41	12.70	77	5.00
-31	121.80	5	36.50	42	12.39	78	4.89
-30	118.13	6	35.52	43	12.09	79	4.78
-29	114.46	7	34.54	44	11.78	80	4.68
-28	110.79	8	33.56	45	11.48	81	4.57
-27	107.12	9	32.58	46	11.17	82	4.46
-26	103.45	10	31.60	47	10.87	83	4.35
-25	99.78	11	30.62	48	10.56	84	4.24
-24	96.11	12	29.64	49	10.26	85	4.14
-23	92.44	13	28.66	50	9.95	86	4.03
-22	88.77	14	27.68	51	9.72	87	3.94
-21	86.16	15	26.96	52	8.10	88	3.86
-20	83.56	16	26.23	53	8.07	89	3.77
-19	80.96	17	25.51	54	8.03	90	3.69
-18	78.35	18	24.79	55	8.00	91	3.61
-17	75.75	19	24.06	56	7.96	92	3.52
-16	73.15	20	23.34	57	7.93	93	3.44
-15	70.54	21	22.61	58	7.89	94	3.35
-14	67.94	22	21.89	59	7.85	95	3.27
13	65.34	23	21.17	60	7.68	96	3.20
-12	63.48	24	20.63	61	7.50	97	3.13
-11	61.62	25	20.09	62	7.32	98	3.07
-10	59.76	26	19.55	63	7.14	99	3.00
-9	57.90	27	19.02	64	6.96	100	2.93
-8	56.05	28	18.48	65	6.78	101	2.87
-7	54.19	29	17.94	66	6.60	102	2.80
-6	52.33	30	17.40	67	6.42	103	2.73
-5	50.47	31	16.87	68	6.25	104	2.66

EcoNet® Enabled Unit Coolers

Part no. 8219637

Suction Temp Thermistor Resistance Table

Fahrenheit	Kilo-Ohms	Fahrenheit	Kilo-Ohms	Fahrenheit	Kilo-Ohms	Fahrenheit	Kilo-Ohms
-40	346.62	-4	97.07	33	31.84	69	12.21
-39	335.84	-3	94.39	34	31.04	70	11.94
-38	325.06	-2	91.71	35	30.23	71	11.66
-37	314.28	-1	89.02	36	29.42	72	11.38
-36	303.50	1	83.66	37	28.62	73	11.11
-35	292.71	2	80.98	38	27.81	74	10.83
-34	281.93	3	78.29	39	27.00	75	10.55
-33	271.15	4	75.61	40	26.20	76	10.28
-32	260.37	5	72.93	41	25.39	77	10.00
-31	249.59	6	70.97	42	24.78	78	9.78
-30	242.04	7	69.02	43	24.17	79	9.57
-29	234.49	8	67.06	44	23.56	80	9.35
-28	226.95	9	65.11	45	22.95	81	9.14
-27	219.40	10	63.15	46	22.34	82	8.92
-26	211.85	11	61.20	47	21.73	83	8.70
-25	204.30	12	59.24	48	21.12	84	8.49
-24	196.76	13	57.29	49	20.51	85	8.27
-23	189.21	14	55.33	50	19.90	86	8.06
-22	181.66	15	53.88	51	19.43	87	7.89
-21	176.32	16	52.44	52	16.21	88	7.72
-20	170.98	17	50.99	53	16.14	89	7.55
-19	165.63	18	49.55	54	16.07	90	7.38
-18	160.29	19	48.10	55	15.99	91	7.21
-17	154.95	20	46.66	56	15.92	92	7.04
-16	149.61	21	45.21	57	15.85	93	6.87
-15	144.26	22	43.77	58	15.78	94	6.70
-14	138.92	23	42.32	59	15.71	95	6.53
13	133.58	24	41.25	60	15.35	96	6.40
-12	129.76	25	40.17	61	14.99	97	6.26
-11	125.94	26	39.10	62	14.64	98	6.13
-10	122.12	27	38.02	63	14.28	99	6.00
-9	118.30	28	36.95	64	13.92	100	5.86
-8	114.48	29	35.87	65	13.56	101	5.73
-7	110.66	30	34.80	66	13.21	102	5.59
-6	106.84	31	33.72	67	12.85	103	5.46
-5	103.02	32	32.65	68	12.49	104	5.33

EcoNet® Enabled Unit Coolers

Part no. 8219621

Suction Pressure Transducer Voltage Table

$V_{out}(DC)$	PSIA	PSIG
0.50	0	-14.7
0.55	2	-12.7
0.61	4	-10.7
0.66	6	-8.7
0.71	8	-6.7
0.77	10	-4.7
0.82	12	-2.7
0.87	14	-0.7
0.93	16	1.3
0.98	18	3.3
1.03	20	5.3
1.09	22	7.3
1.14	24	9.3
1.19	26	11.3
1.25	28	13.3
1.30	30	15.3
1.35	32	17.3
1.41	34	19.3
1.46	36	21.3
1.51	38	23.3
1.57	40	25.3
1.62	42	27.3
1.67	44	29.3
1.73	46	31.3
1.78	48	33.3
1.83	50	35.3
1.89	52	37.3
1.94	54	39.3
1.99	56	41.3
2.05	58	43.3
2.10	60	45.3
2.15	62	47.3
2.21	64	49.3
2.26	66	51.3
2.31	68	53.3
2.37	70	55.3
2.42	72	57.3
2.47	74	59.3

$V_{out}(DC)$	PSIA	PSIG
2.53	76	61.3
2.58	78	63.3
2.63	80	65.3
2.69	82	67.3
2.74	84	69.3
2.79	86	71.3
2.85	88	73.3
2.90	90	75.3
2.95	92	77.3
3.01	94	79.3
3.06	96	81.3
3.11	98	83.3
3.17	100	85.3
3.22	102	87.3
3.27	104	89.3
3.33	106	91.3
3.38	108	93.3
3.43	110	95.3
3.49	112	97.3
3.54	114	99.3
3.59	116	101.3
3.65	118	103.3
3.70	120	105.3
3.75	122	107.3
3.81	124	109.3
3.86	126	111.3
3.91	128	113.3
3.97	130	115.3
4.02	132	117.3
4.07	134	119.3
4.13	136	121.3
4.18	138	123.3
4.23	140	125.3
4.29	142	127.3
4.34	144	129.3
4.39	146	131.3
4.45	148	133.3
4.50	150	135.3