



D Series

*Air Cooled
Condensing Units*

3 to 22 HP

Brochure 530.10

MAY, 2007



The outdoor housing of our condensing units have completely re-engineered. Access to all components is now more convenient than ever. Quick removal of top and side panels allows quick access to everything. The hinged control panel door swings wide open for maximum clearance while the unit is being serviced.

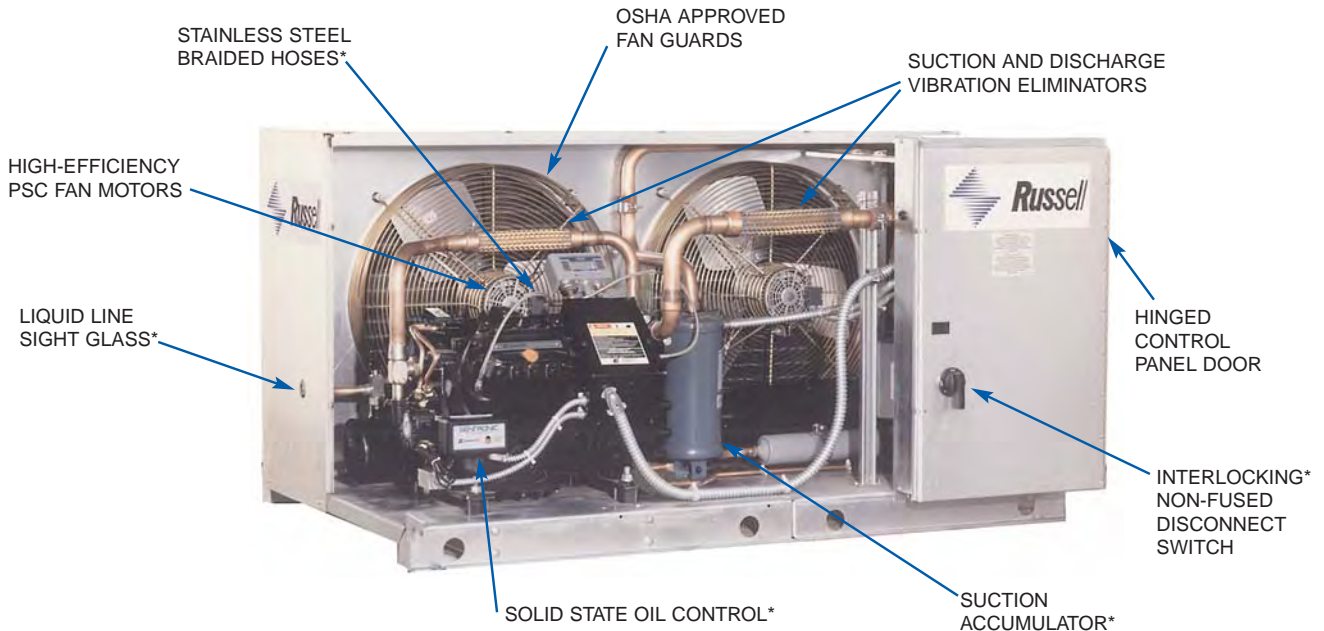

The **large** control panel has abundant space for the controls you choose. They are intelligently arranged and laid out in a logical fashion which is easy to understand and work with. Each control and wire is clearly marked with a name or number as shown on the wiring diagram which is conveniently affixed to the control panel door.

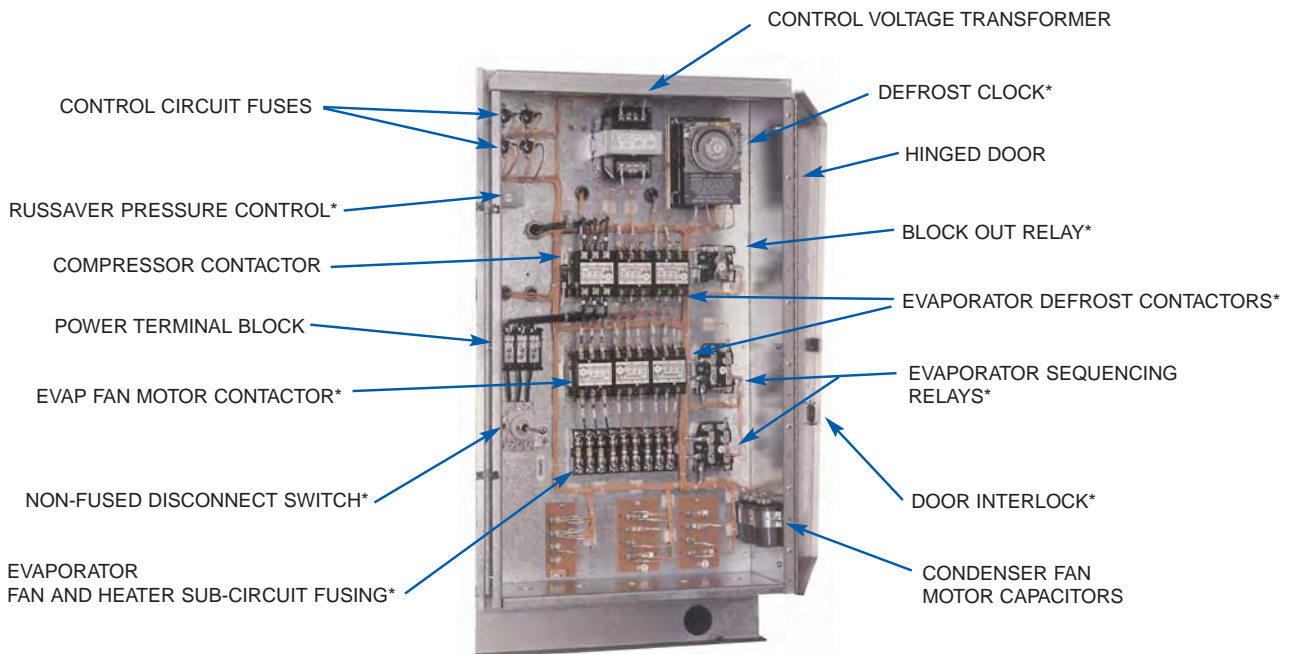

MODEL NUMBER NOMENCLATURE

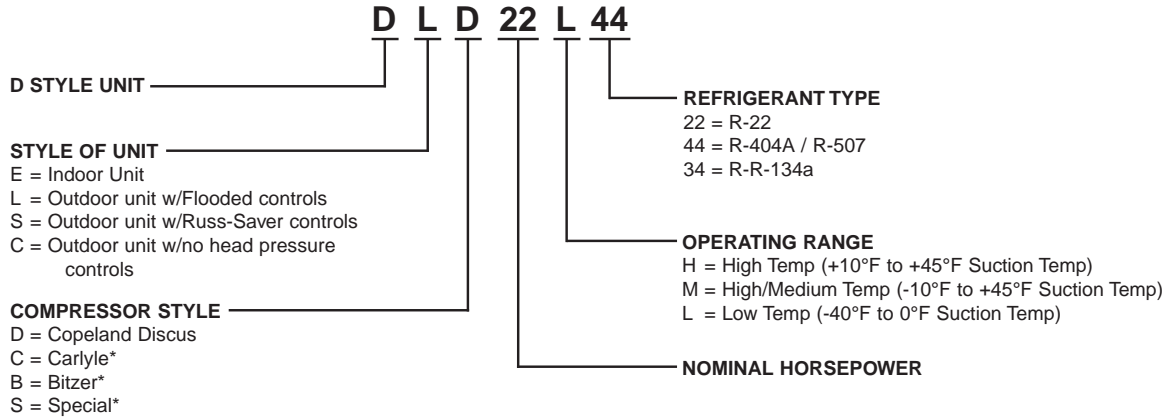

	FEATURES AT A GLANCE	MODEL			
		DE	DC	DS	DL
ELECTRICAL COMPONENTS	Crankcase heater	OPT.	STD	STD	STD
	Oil failure control - as required	STD	STD	STD	STD
	High-Low pressure control - manual(high)/automatic(low)rest	STD	STD	STD	STD
	Compressor contactor	STD	STD	STD	STD
	Control circuit fuses - standard 230/1	STD	STD	STD	STD
	Power terminal block	OPT.	STD	STD	STD
CONDENSER	Copper tubes with Aluminum fins	STD	STD	STD	STD
	Subcooling circuit	STD	STD	STD	STD
	Fan motor - PSC overload protection	STD	STD	STD	STD
	Fan blade - individually balanced	STD	STD	STD	STD
	Fan guard - split for easy motor access: UL listed	STD	STD	STD	STD
PIPING COMPONENTS	Suction line filter	OPT.	STD	STD	STD
	Suction line vibration eliminator	OPT.	STD	STD	STD
	Liquid line filter/drier	OPT.	STD	STD	STD
	Sight glass/moisture indicator	OPT.	STD	STD	STD
	Discharge line vibration eliminator	STD	STD	STD	STD
	Inlet and outlet isolation valves	STD	STD	STD	STD
RECEIVER	Fusible plug	STD	STD	STD	STD
HOUSING	All weather housing	OPT.	STD	STD	STD
	Control panel - with hinged door	STD	STD	STD	STD
	Raised galvanized steel base	STD	STD	STD	STD
LOW AMBIENT CONTROLS	Russ-Saver - all ambient energy saver	N/A	N/A	STD	N/A
	Pressure fan cycling control -not available on 3HP -6HP low temps.	OPT.	OPT.	STD	N/A
	Flooded condenser	OPT.	OPT.	N/A	STD
TESTING	UL/cUL listed all models	STD	STD	STD	STD
	Leak detection, Dielectric & Run test	STD	STD	STD	STD
	Dry nitrogen holding charge	STD	STD	STD	STD

- OPTIONS:**
- 4 year extended compressor warranty
 - Air defrost time clock
 - Compressor unloading
 - Copper or coated condenser fins
 - Crankcase pressure regulator
 - Electric Defrost with heater contactors, timer, block out relay
 - Evap sub circuit fusing
 - Fused disconnect
 - Heated and insulated receiver

- Hot Gas Defrost components
- Liquid line solenoid valve
- Oil separator
- Oversized receiver
- Phase loss monitor
- Sentronic oil safety control
- Spring loaded relief valve
- Stainless steel hoses
- Suction line accumulator
- Non-Fused Disconnect

* Contact factory for details.

RUSS-SAVER

The initial cost of quality refrigeration equipment is a substantial investment. But the **costs** of installation and operation are also formidable. Rising to the challenge, Russell engineers have designed the **RUSS-SAVER** system to meet the highest standards of performance and reliability while effectively addressing the problem of these profit draining costs.

- **REDUCED INSTALLATION COSTS**

The installation of a refrigeration system using **RUSS-SAVER** requires a smaller refrigerant charge than equipment which utilize other types of low ambient controls. As the more expensive zero ozone depleting, refrigerants become the refrigerants of choice, the reduced charge requirements provided by **RUSS-SAVER** affords **substantial and immediate cost saving benefits.**

- **REDUCED OPERATING COSTS**

The most expensive part of an operating refrigeration system is the cost of energy to operate the compressor. Day and night, year after year, the cost of electricity to operate your equipment is **unrelenting**. These dollars are pulled right from your bottom line.

A typical installation provides for equipment which is designed to furnish adequate cooling on the hottest of days. The **RUSS-SAVER** system is designed to meet this need but also be flexible enough to take advantage of reduced ambient conditions during off-peak times. As the outside air temperature decreases, head pressures are allowed to drop. This action results in increased efficiency, requiring less energy and **saving substantial amounts of your money!**

- **RUSS-SAVER even saves money during hot weather.**

The sub cooling loop provided in the condenser of the **RUSS-SAVER** condensing unit increases the system efficiency 1/2% for each degree of sub cooling provided, thereby making the compressor's job easier. **RUSS-SAVER'S** efficiency saves you money during summer operation and even more during the winter months.

RUSS-SAVER

ENERGY SAVINGS CALCULATIONS

To estimate your average monthly savings:

- 1) Select a RUSS-SAVER system that meets your refrigeration requirements.
- 2) Determine the Average Annual Outdoor Air Temperature from the table below.
- 3) Using the Projected Monthly Savings graph, locate the system nominal horsepower at the bottom of the graph (the nominal system horsepower can be derived from the model number nomenclature).
- 4) Go straight up to the appropriate Average Annual Outdoor Air Temperature curve, and then go horizontally to the left to determine your Estimated Monthly Average Savings.
- 5) To calculate your Estimated Monthly Saving for an energy cost other than \$0.10 KWH, divide the Estimated Monthly Savings by 0.10 and multiply by your local electric utility rate.
- 6) To determine your Estimated Yearly Savings, multiple the Estimated Monthly Savings number by 12.

AVERAGE ANNUAL OUTDOOR AIR TEMPERATURE

STATE & STATION	ANNUAL AVG. °F	STATE & STATION	ANNUAL AVG. °F	STATE & STATION	ANNUAL AVG. °F	STATE & STATION	ANNUAL AVG. °F
AL Mobile	70	IA Des Moines	50	NM Albuquerque	60	VT Burlington	45
AK Juneau	40	KS Wichita	55	NY Buffalo	45	VA Richmond	60
AZ Phoenix	70	KY Louisville	55	NY New York	55	WA Seattle	50
AR Little Rock	60	LA New Orleans	70	NC Charlotte	60	WV Charleston	55
CA Los Angeles	60	ME Portland	45	ND Bismarck	45	WI Milwaukee	45
		MD Baltimore	55	OH Cleveland	50	WY Cheyenne	45
CO Denver	50	MA Boston	50				
CT Hartford	50	MI Detroit	50	OK Oklahoma City	60		CANADA
DE Wilmington	55	MN Saut St. Marie	40	OR Portland	55	ALB Calgary	40
D.C. Washington	55			PA Philadelphia	50	B.C. Vancouver	50
FL Jacksonville	70	MS Jackson	65	RI Providence	50	MAN Winnipeg	35
		MO St. Louis	55	SC Columbia	65	N.B. St. John	45
GA Atlanta	60	MT Great Falls	45	SD Sioux Falls	45	N.F. St. John's	40
HI Honolulu	75	NE Omaha	50	TN Nashville	60	N.S. Halifax	45
ID Boise	50	NV Reno	50	TX Dallas	65	ONT Toronto	45
IL Chicago	50	NH Concord	45			QUE Montreal	45
IN Indianapolis	50	NJ Atlantic City	55	UT Salt Lake City	50	YUK Dawson	25

RUSS-SAVER PROJECTED MONTHLY SAVINGS @ \$0.10/KWH

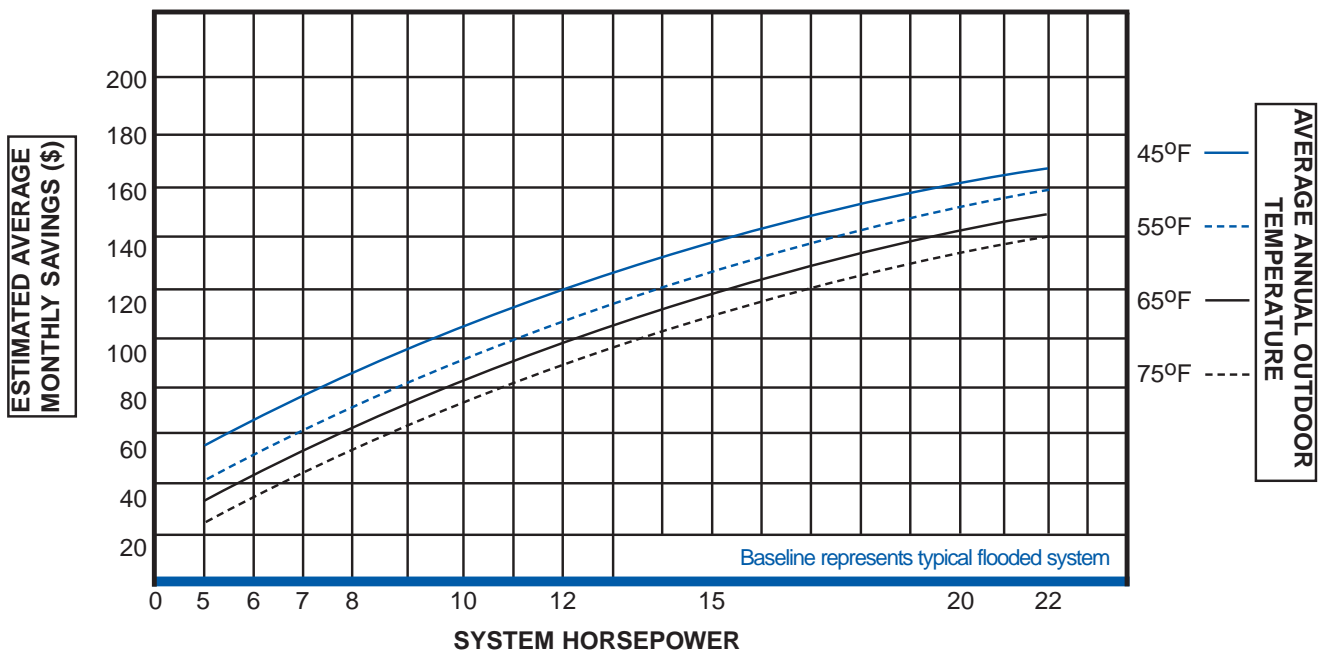

BTUH CAPACITIES

R-22 HIGH TEMP

SUCTION TEMPERATURE °F

90° AMBIENT	DE/DC/DS/DL	+45°	+40°	+35°	+25°	+20°	+10°
	5H22	79,700	72,600	65,900	53,600	47,900	37,800
	7H22	109,300	99,700	90,600	74,200	66,800	53,600
	8H22	136,000	124,200	113,000	92,800	83,700	67,200
	10H22	158,600	144,900	132,200	109,200	98,800	80,200
	12H22	183,000	166,200	150,200	126,100	113,100	90,400
	15H22	210,300	192,600	175,800	145,200	131,300	105,800

95° AMBIENT	DE/DC/DS/DL	+45°	+40°	+35°	+25°	+20°	+10°
	5H22	76,900	70,100	63,600	51,700	46,300	36,400
	7H22	105,800	96,500	87,800	71,900	64,800	52,100
	8H22	131,600	120,100	109,400	89,800	80,900	64,900
	10H22	153,400	140,200	127,900	105,600	95,500	77,500
	12H22	176,800	160,500	145,100	121,800	109,200	87,300
	15H22	203,300	186,300	173,200	140,700	127,200	102,600

100° AMBIENT	DE/DC/DS/DL	+45°	+40°	+35°	+25°	+20°	+10°
	5H22	74,100	67,500	61,300	49,900	44,700	35,100
	7H22	102,200	93,300	84,900	69,600	62,800	50,500
	8H22	127,100	116,100	105,700	86,800	78,200	62,600
	10H22	148,100	135,500	123,600	102,000	92,300	74,800
	12H22	170,700	154,900	140,100	117,600	105,400	84,300
	15H22	196,600	180,200	164,700	136,300	123,300	99,400

110° AMBIENT	DE/DC/DS/DL	+45°	+40°	+35°	+25°	+20°	+10°
	5H22	68,500	62,500	56,800	46,300	41,500	32,500
	7H22	94,700	86,500	78,800	64,900	58,600	47,400
	8H22	118,300	108,100	98,500	80,800	72,800	58,100
	10H22	137,600	125,900	115,000	94,900	85,800	69,300
	12H22	153,300	139,200	125,900	105,700	94,700	75,800
	15H22	183,600	168,300	154,100	127,900	115,700	93,300

BTUH CAPACITIES

R-22 LOW TEMP

SUCTION TEMPERATURE °F

90° AMBIENT	DE/DC/DS/DL	0°	-10°	-20°	-25°	-30°	-40°
	3L22	31,000	23,500	17,600	15,100	12,800	8,700
	4L22	36,500	28,000	20,700	17,400	14,600	9,900
	5L22	42,600	33,100	24,600	20,900	17,600	12,000
	6L22	50,500	38,700	29,600	25,500	21,200	14,800
	8L22	59,300	46,600	35,600	30,700	26,600	19,100
	9L22	67,900	53,400	40,700	35,200	30,100	21,300
	10L22	77,300	60,400	45,500	39,600	33,900	23,300
	15L22	110,400	86,800	66,400	57,400	48,800	33,900
	22L22	129,500	100,600	77,800	67,900	58,700	40,600

95° AMBIENT	DE/DC/DS/DL	0°	-10°	-20°	-25°	-30°	-40°
	3L22	29,400	22,300	16,700	14,300	12,100	8,200
	4L22	34,800	26,700	19,700	16,600	13,900	9,400
	5L22	40,300	31,300	23,300	19,800	16,600	11,300
	6L22	47,900	36,700	28,100	24,200	20,100	14,000
	8L22	56,400	44,300	33,900	29,200	25,300	18,100
	9L22	64,700	50,900	38,800	33,500	28,700	20,300
	10L22	73,400	57,400	43,200	37,600	32,200	22,100
	15L22	105,400	82,900	63,400	54,800	46,600	32,300
	22L22	123,200	95,700	74,000	64,600	55,800	38,600

100° AMBIENT	DE/DC/DS/DL	0°	-10°	-20°	-25°	-30°	-40°
	3L22	27,900	21,200	15,900	13,600	11,500	7,800
	4L22	33,200	25,500	18,800	15,900	13,300	9,000
	5L22	38,100	29,600	22,100	18,800	15,700	10,700
	6L22	45,500	34,800	26,700	23,000	19,100	13,300
	8L22	53,600	42,100	32,300	27,800	24,100	17,200
	9L22	61,500	48,400	36,900	31,800	27,300	19,300
	10L22	70,500	55,200	41,500	36,100	31,000	21,300
	15L22	100,500	79,100	60,500	52,300	44,500	30,800
	22L22	118,200	91,800	71,000	62,000	53,600	37,100

110° AMBIENT	DE/DC/DS/DL	0°	-10°	-20°	-25°	-30°	-40°
	3L22	24,300	18,400	13,800	11,800	10,000	6,800
	4L22	28,600	21,900	16,200	13,700	11,400	7,800
	5L22	31,500	24,500	18,200	15,500	13,000	8,900
	6L22	38,400	29,400	22,500	19,400	16,100	11,200
	8L22	45,700	35,900	27,500	23,700	20,500	14,700
	9L22	53,100	41,800	31,900	27,500	23,600	16,700
	10L22	61,700	48,300	36,300	31,600	27,100	18,600
	15L22	86,500	68,000	52,000	45,000	38,300	26,500
	22L22	102,300	79,500	61,500	53,700	46,400	32,100

BTUH CAPACITIES

R-404A / R-507 - HIGH / MEDIUM TEMP

SUCTION TEMPERATURE °F

90° AMBIENT

DE/DC/DS/DL	+45°	+35°	+25°	+20°	+10°	0°	-10°
5M44	81,000	68,800	57,200	51,700	41,800	33,100	26,000
6M44	103,100	86,300	71,100	64,300	51,700	41,000	32,300
7M44	114,800	96,700	80,500	73,100	59,800	48,100	38,100
8M44	135,000	114,600	96,000	87,400	71,500	57,500	45,600
10M44	159,600	135,300	113,700	103,700	85,200	69,000	54,500
12M44	197,000	161,300	135,500	123,500	101,700	82,400	65,700
15M44	210,000	179,300	151,200	138,100	114,000	92,700	73,800

95° AMBIENT

DE/DC/DS/DL	+45°	+35°	+25°	+20°	+10°	0°	-10°
5M44	76,700	65,100	54,100	48,900	39,500	31,300	24,600
6M44	97,600	81,700	67,300	60,800	48,900	38,800	30,500
7M44	109,000	91,800	76,400	69,400	56,700	45,600	36,100
8M44	128,300	108,900	91,200	83,000	67,900	54,600	43,300
10M44	151,700	128,600	108,000	98,500	80,900	65,500	51,800
12M44	187,000	153,100	128,600	117,200	96,500	78,200	62,300
15M44	199,200	170,100	143,400	131,000	108,100	87,900	70,000

100° AMBIENT

DE/DC/DS/DL	+45°	+35°	+25°	+20°	+10°	0°	-10°
5M44	72,200	61,300	51,000	46,100	37,200	29,500	23,200
6M44	91,900	76,900	63,400	57,300	46,100	36,600	28,800
7M44	103,100	86,800	72,200	65,600	53,600	43,100	34,200
8M44	121,400	103,100	86,300	78,600	64,300	51,700	41,000
10M44	143,400	121,600	102,100	93,100	76,500	61,900	49,000
12M44	176,400	144,400	121,300	110,600	91,000	73,800	58,800
15M44	187,900	160,500	135,300	123,600	102,000	82,900	66,100

110° AMBIENT

DE/DC/DS/DL	+45°	+35°	+25°	+20°	+10°	0°	-10°
5M44	61,400	52,100	43,300	39,200	31,600	25,100	19,700
6M44	78,100	65,400	53,900	48,700	39,200	31,100	24,400
7M44	88,900	74,900	62,300	56,600	46,300	37,200	29,500
8M44	105,400	89,500	74,900	68,200	55,800	44,900	35,600
10M44	123,800	105,000	88,200	80,400	66,100	53,500	42,300
12M44	151,900	124,400	104,500	95,200	78,400	63,500	50,600
15M44	161,200	137,700	116,100	106,000	87,500	71,200	56,700

BTUH CAPACITIES

R-404A / R-507 - LOW TEMP

SUCTION TEMPERATURE °F

90° AMBIENT

DE/DC/DS/DL	0°	-10°	-15°	-20°	-25°	-30°	-40°
3L44	32,200	26,600	23,600	20,600	17,900	15,500	11,100
4L44	39,300	31,400	27,700	24,400	21,300	18,400	13,200
5L44	46,500	37,400	33,400	29,500	25,900	22,500	16,400
6L44	53,200	42,200	37,300	32,800	28,600	24,700	18,100
8L44	67,000	53,500	47,300	41,700	36,700	31,900	23,700
9L44	77,700	62,200	55,300	49,000	43,100	37,900	28,500
10L44	85,600	69,500	61,000	55,000	48,300	42,100	31,000
12L44	92,000	74,100	66,100	58,800	51,800	45,100	32,100
15L44	114,200	91,400	81,000	71,500	62,700	54,700	40,800
22L44	135,500	110,700	99,500	88,000	79,200	70,200	54,300

95° AMBIENT

DE/DC/DS/DL	0°	-10°	-15°	-20°	-25°	-30°	-40°
3L44	30,600	25,300	22,400	19,600	17,000	14,700	10,500
4L44	37,300	29,800	26,300	23,100	20,200	17,400	12,500
5L44	44,000	35,400	31,600	27,900	24,500	21,300	15,500
6L44	50,500	40,000	35,400	31,100	27,100	23,400	17,100
8L44	63,600	50,800	44,900	39,600	34,800	30,300	22,500
9L44	73,700	59,000	52,500	46,500	40,900	35,900	27,000
10L44	81,200	65,900	57,800	52,100	45,800	39,900	29,400
12L44	87,400	70,400	62,800	55,800	49,200	42,800	30,500
15L44	108,600	92,900	82,200	73,600	63,900	54,600	40,500
22L44	128,600	105,100	94,400	83,500	75,200	66,600	51,500

100° AMBIENT

DE/DC/DS/DL	0°	-10°	-15°	-20°	-25°	-30°	-40°
3L44	29,100	24,100	21,300	18,700	16,200	14,000	10,000
4L44	35,600	28,400	25,100	22,000	19,300	16,600	11,900
5L44	41,900	33,700	30,100	26,600	23,300	20,300	14,800
6L44	48,200	38,200	33,800	29,700	25,900	22,400	16,300
8L44	60,700	48,500	42,900	37,800	33,200	29,000	21,500
9L44	70,200	56,200	50,000	44,300	39,000	34,200	25,800
10L44	77,400	62,800	55,100	49,600	43,700	38,000	28,000
12L44	83,200	67,000	59,800	53,100	46,800	40,800	29,100
15L44	103,500	89,200	77,900	70,600	64,500	52,400	38,900
22L44	122,500	100,100	89,900	79,500	71,600	63,500	49,100

110° AMBIENT

DE/DC/DS/DL	0°	-10°	-15°	-20°	-25°	-30°	-40°
3L44	26,100	21,600	19,100	16,700	14,500	12,600	9,000
4L44	31,800	25,400	22,500	19,700	17,300	14,900	10,700
5L44	37,600	30,300	27,000	23,900	21,000	18,200	13,300
6L44	43,100	34,200	30,200	26,600	23,200	20,000	14,600
8L44	54,200	43,300	38,300	33,700	29,700	25,800	19,200
9L44	62,800	50,300	44,800	39,700	34,900	30,600	23,100
10L44	69,300	56,300	49,400	44,500	39,100	34,100	25,100
12L44	74,700	60,200	53,700	47,700	42,100	36,600	26,100
15L44	92,600	80,100	69,900	63,400	48,900	47,000	34,900
22L44	109,700	89,700	80,600	71,300	64,200	56,900	44,000

ELECTRICAL SPECIFICATIONS

MODEL NUMBER DE/ DC/ DS/DL	COMPRESSOR MODEL	230/3/60			TOTAL* UNIT AMPS	MCA*	460/3/60			TOTAL* UNIT AMPS	MCA*
		COMP.		COND.			COMP.		COND.		
		RLA	LRA	FLA			RLA	LRA	FLA		

HIGH TEMP - R-22

5H22	2DD-R63KE	22.3	120.0	4.2	27.5	34.0	10.5	60.0	2.1	13.1	16.0
7H22	2DA-R89KE	32.0	169.0	6.4	39.4	48.0	14.1	85.0	4.2	18.8	23.0
8H22	3DA-R10ME	41.0	215.0	6.4	48.4	59.0	20.0	106.0	4.2	24.7	30.0
10H22	3DB-R12ME	43.6	215.0	8.4	53.0	64.0	20.0	106.0	4.2	24.7	30.0
12H22	3DF-R15ME	48.2	275.0	8.4	57.6	70.0	23.6	138.0	4.2	28.3	35.0
15H22	3DS-R17ME	59.6	275.0	8.4	69.0	84.0	29.0	138.0	4.2	33.7	41.0

LOW TEMP - R-22

3L22	2DF-F16KE	16.8	102.0	3.2	21.0	26.0	8.1	52.0	2.1	10.7	13.0
4L22	2DL-F20KE	26.3	161.0	3.2	30.5	38.0	10.2	60.0	2.1	12.8	16.0
5L22	2DA-F23KE	28.8	161.0	3.2	33.0	41.0	10.2	60.0	2.1	12.8	16.0
6L22	3DA-F28KE	30.3	150.0	4.2	35.5	44.0	13.7	77.0	2.1	16.3	20.0
8L22	3DB-F33KE	31.5	161.0	6.4	38.9	47.0	16.1	83.0	4.2	20.8	25.0
9L22	3DF-F40KE	39.0	215.0	6.4	46.4	57.0	16.9	106.0	4.2	21.6	26.0
10L22	3DS-F46KE	42.0	215.0	6.4	49.4	60.0	18.6	106.0	4.2	23.3	28.0
15L22	4DL-F63KE	52.6	278.0	8.4	62.0	76.0	26.3	139.0	4.2	31.0	38.0
22L22	4DT-F76KE	66.0	374.0	8.4	75.4	92.0	33.0	187.0	4.2	37.7	46.0

MEDIUM TEMP - R-404A / R-507

5M44	2DD-R63KE	22.3	120.0	4.2	27.5	34.0	10.5	60.0	2.1	13.1	16.0
6M44	2DL-R78KE	31.6	169.0	6.4	39.4	47.0	13.8	85.0	4.2	18.5	22.0
7M44	2DA-R89KE	32.0	169.0	6.4	39.4	48.0	14.1	85.0	4.2	18.8	23.0
8M44	3DA-R10ME	41.0	215.0	6.4	48.8	59.0	20.0	106.0	4.2	24.7	30.0
10M44	3DB-R12ME	43.6	215.0	8.4	53.0	64.0	20.0	106.0	4.2	24.7	30.0
12M44	3DF-R15ME	48.2	275.0	8.4	57.6	70.0	23.6	138.0	4.2	28.3	35.0
15M44	3DS-R17ME	59.6	275.0	8.4	69.0	84.0	29.0	138.0	4.2	33.7	41.0

LOW TEMP - R-404A / R-507

3L44	2DF-F16KE	16.8	102.0	3.2	21.0	26.0	8.1	52.0	2.1	10.7	13.0
4L44	2DL-F20KE	26.3	161.0	3.2	30.5	38.0	10.2	60.0	2.1	12.8	16.0
5L44	2DA-F23KE	28.8	161.0	3.2	33.0	41.0	10.2	60.0	2.1	12.8	16.0
6L44	3DA-F28KE	30.3	150.0	3.2	34.5	43.0	13.7	77.0	2.1	16.3	20.0
8L44	3DB-F33KE	31.5	161.0	6.4	38.9	47.0	16.1	83.0	4.2	20.8	25.0
9L44	3DF-F40KE	39.0	215.0	6.4	46.4	57.0	16.9	106.0	4.2	21.6	26.0
10L44	3DS-F46KE	42.0	215.0	6.4	49.4	60.0	18.6	106.0	4.2	32.3	28.0
12L44	4DA-F47KE	45.6	220.0	6.4	53.0	65.0	22.8	110.0	4.2	27.5	34.0
15L44	4DL-F63KE	52.6	278.0	8.4	62.0	76.0	26.3	139.0	4.2	31.0	38.0
22L44	4DT-F76KE	66.0	374.0	8.4	75.5	92.0	33.0	187.0	4.2	37.7	46.0

* Does not include evaporator electrical loads.

MCA = Minimum Circuit Ampacity

PHYSICAL DATA

MODEL NUMBER DE/DC/ DS/DL	COMPRESSOR DATA		DRW. NO.*	APPROXIMATE PHYSICAL DIMENSIONS (In)			REC. CAP @ 90% LBS.	CONNECTION SIZE (In)		APPROX. WEIGHT (LBS.)	
	COMP. MODEL	CFH		H	L	D		LIQ.	SUCT.	DE	DC/DS/DL

HIGH TEMP - R-22

5H22	2DD-R63KE	823	1	37-1/4	38	48	32.0	5/8	1-1/8	580	850
7H22	2DA-R89KE	1135	2	37-1/4	68	48	61.0	5/8	1-3/8	740	1100
8H22	3DA-R10ME	1375	2	37-1/4	68	48	61.0	5/8	1-3/8	760	1130
10H22	3DB-R12ME	1620	2	37-1/4	68	48	61.0	7/8	1-5/8	900	1330
12H22	3DF-R15ME	1913	2	37-1/4	68	48	61.0	7/8	1-5/8	910	1340
15H22	3DS-R17ME	2120	2	44-3/4	68	48	96.0	7/8	1-5/8	920	1350

LOW TEMP - R-22

3L22	2DF-F16KE	904	1	37-1/4	38	48	32.0	3/8	1-1/8	480	710
4L22	2DL-F20KE	1008	1	37-1/4	38	48	32.0	3/8	1-1/8	510	740
5L22	2DA-F23KE	1191	1	37-1/4	38	48	32.0	3/8	1-3/8	550	805
6L22	3DA-F28KE	1375	1	37-1/4	38	48	32.0	3/8	1-3/8	575	840
8L22	3DB-F33KE	1620	2	37-1/4	68	48	61.0	5/8	1-3/8	760	1130
9L22	3DF-F40KE	1915	2	37-1/4	68	48	61.0	5/8	1-5/8	840	1275
10L22	3DS-F46KE	2120	2	37-1/4	68	48	61.0	5/8	1-5/8	840	1275
15L22	4DL-F63KE	3020	2	37-1/4	68	48	61.0	5/8	1-5/8	890	1310
22L22	4DT-F76KE	3603	2	44-3/4	68	48	96.0	7/8	2-1/8	980	1420

MEDIUM TEMP - R-404A / R-507

5M44	2DD-R63KE	823	1	37-1/4	38	48	27.0	5/8	1-1/8	580	850
6M44	2DL-R78KE	1008	2	37-1/4	68	48	27.0	5/8	1-1/8	650	1075
7M44	2DA-R89KE	1135	2	37-1/4	68	48	52.0	5/8	1-3/8	740	1100
8M44	3DA-R10ME	1375	2	37-1/4	68	48	52.0	5/8	1-3/8	760	1130
10M44	3DB-R12ME	1620	2	37-1/4	68	48	52.0	7/8	1-5/8	900	1330
12M44	3DF-R15ME	1915	2	37-1/4	68	48	52.0	7/8	1-5/8	900	1330
15M44	3DS-R17ME	2120	2	44-3/4	68	48	82.0	7/8	1-5/8	920	1350

LOW TEMP - R-404A / R-507

3L44	2DF-F16KE	904	1	37-1/4	38	48	27.0	1/2	1-1/8	480	710
4L44	2DL-F20KE	1008	1	37-1/4	38	48	27.0	1/2	1-1/8	520	760
5L44	2DA-F23KE	1191	1	37-1/4	38	48	27.0	1/2	1-3/8	550	805
6L44	3DA-F28KE	1375	1	37-1/4	38	48	27.0	1/2	1-3/8	605	870
8L44	3DB-F33KE	1620	2	37-1/4	68	48	52.0	5/8	1-3/8	760	1130
9L44	3DF-F40KE	1915	2	37-1/4	68	48	52.0	5/8	1-5/8	840	1275
10L44	3DS-F46KE	2120	2	37-1/4	68	48	52.0	5/8	1-5/8	840	1275
12L44	4DA-F47KE	2380	2	37-1/4	68	48	52.0	5/8	1-5/8	855	1290
15L44	4DL-F63KE	3020	2	37-1/4	68	48	52.0	5/8	1-5/8	890	1310
22L44	4DT-F76KE	3603	2	44-3/4	68	48	82.0	7/8	2-1/8	980	1420

* See back cover.

DRAWINGS

INDOOR UNITS

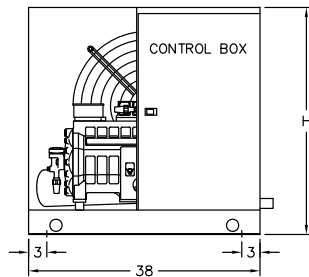

FRONT VIEW - 1 FAN
MODEL DE

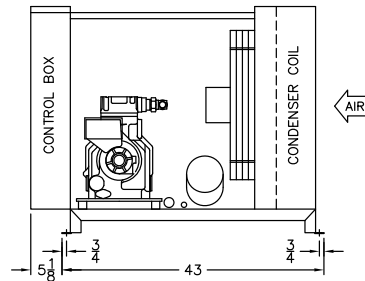

RIGHT SIDE VIEW
MODEL DE

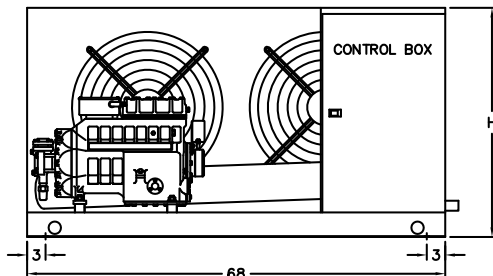

FRONT VIEW - 2 FAN
MODEL DE

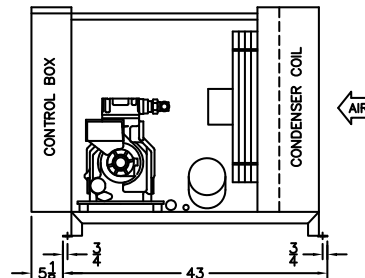

RIGHT SIDE VIEW
MODEL DE

OUTDOOR UNITS

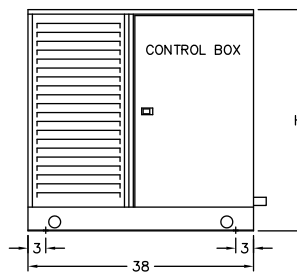

FRONT VIEW - 1 FAN
MODEL DC/DL/DS

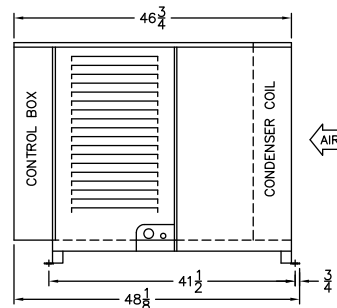

RIGHT SIDE VIEW
MODEL DC/DL/DS

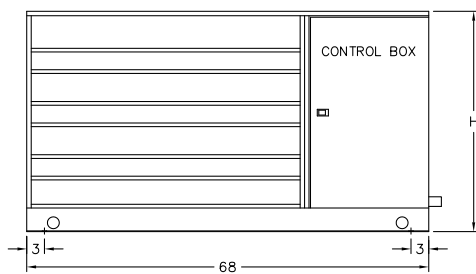

FRONT VIEW - 2 FAN

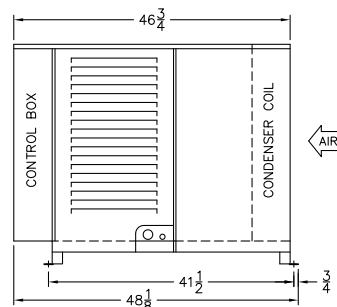

RIGHT SIDE VIEW

See Physical Data page for the appropriate number of condenser fans.